

ISSN 0011-7145

dio

THE SOUND ENGINEERING MAGAZINE
NOVEMBER 1976 \$1.00

AKUOWA325COM11 11 DB
JAN79
KUOW RADIO
D 5 50 UNIV OF WASH
325 COMMUNICATIONS BLDG
SEATTLE WA 98105



STUDIO AUTOMATION ISSUE:

- Automix
- Memory Plus
- NECAM

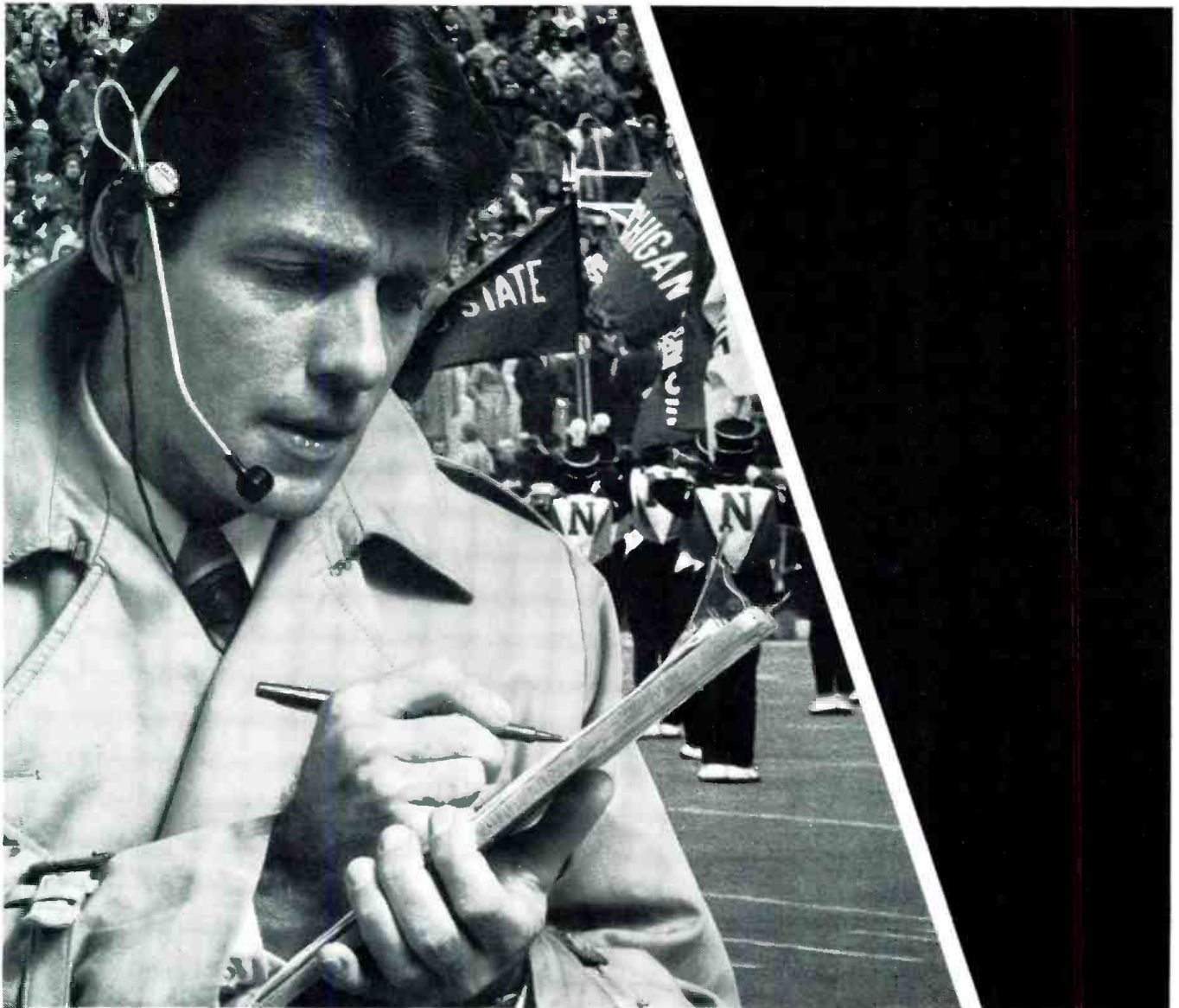

**Next best thing
to a sound proof booth.**

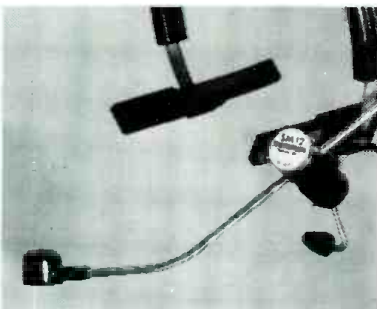

Shure's new headset microphones are coming through loud and clear. With their unique miniature dynamic element placed right at the end of the boom, Shure's broadcast team eliminates the harsh "telephone" sound and standing waves generated by hollow-tube microphones. The SM10 microphone and the SM12 microphone/receiver have a unidirectional pickup pattern that rejects unwanted background noise, too. In fact, this is the first practical headset microphone that offers a high quality frequency response, effective noise rejection, unobstructed vision design, and unobtrusive size.

Shure Brothers Inc.
222 Hartrey Ave., Evanston, IL 60204
In Canada: A. C. Simmonds & Sons Limited



Manufacturers of high fidelity components, microphones, sound systems and related circuitry.

Circle 10 on Reader Service Card

www.americanradiohistory.com

**coming
next
month**

● Space this month did not permit the inclusion of the previously promised article on the AMPEX ATR-100 SYSTEM. This detailed look at its creation and working will be in December.

● Mortimer Goldberg is technical supervisor with CBS Radio in New York City. He has been responsible during his 25-year career for the editing of many documentaries and he brings this expertise to bear in his article THE ART OF TAPE EDITING.

**about
the
cover**



● A bird's eye view of music in on-stage production.

db

THE SOUND ENGINEERING MAGAZINE

NOVEMBER 1976, VOLUME 10, NUMBER 11

30	AUTOMATION: A LOOK AT AUTOMIX John Woram
32	AUTOMATION: PAUL BUFF AND THE "MEMORY PLUS" John Woram
34	AUTOMATION: MEET NEVE'S NECAM J. Borwick
2	INDEX TO ADVERTISERS
2	LETTERS
4	CALENDAR
6	BROADCAST SOUND Patrick S. Finnegan
14	THEORY AND PRACTICE Norman H. Crowhurst
20	SOUND WITH IMAGES Martin Dickstein
22	THE SYNC TRACK John M. Woram
24	NEW PRODUCTS AND SERVICES
37	CLASSIFIED
40	PEOPLE, PLACES, HAPPENINGS

db is listed in **Current Contents: Engineering and Technology**

Robert Bach PUBLISHER	Larry Zide EDITOR
Bob Laurie ART DIRECTOR	John Woram ASSOCIATE EDITOR
Eloise Beach CIRCULATION MANAGER	Hazel Krantz COPY EDITOR
Lydia Anderson ASST. CIRCULATION MANAGER	Ann Russell PRODUCTION
GRAPHICS Crescent Art Service	

db, the Sound Engineering Magazine is published monthly by Sagamore Publishing Company, Inc. Entire contents copyright © 1976 by Sagamore Publishing Co., Inc., 1120 Old Country Road, Plainview, L.I., N.Y. 11803. Telephone (516) 433 6530. db is published for those individuals and firms in professional audio-recording, broadcast, audio-visual, sound reinforcement, consultants, video recording, film sound, etc. Application should be made on the subscription form in the rear of each issue. Subscriptions are \$7.00 per year (\$14.00 per year outside U. S. Possessions, Canada, and Mexico) in U. S. funds. Single copies are \$1.00 each. Controlled Circulation postage paid at Harrisburg, Pa. 17105. Editorial, Publishing, and Sales Offices: 1120 Old Country Road, Plainview, New York 11803. Postmaster: Form 3579 should be sent to above address.

Soundcraftsmen
**"TOTAL-SYSTEM"
 EQUALIZATION AIDS**

NEW FULL-SPECTRUM 18dB
 LEVEL CONTROLS; LED's
 for ZERO-GAIN and OVERLOAD
 MONITORING; 1dB MARKINGS



Soundcraftsmen
 SPECTRUM/BALANCED OCTAVE EQUALIZER
 PROFESSIONAL TWIN—GRAPHIC MODEL TG 2209-800

NEW 1/3 OCTAVE PINK NOISE
 INSTRUCTIONAL TEST
 RECORD for OCTAVE-WIDE
 ENVIRONMENTAL SET-UP



FOR THE STUDIO

NEW



600-OHM BALANCED IN/OUT

FOR THE ROAD

NEW



SG-2205-600 less case — \$399.50

GUARANTEED SPECIFICATIONS

FREQUENCY RESPONSE: ± 0.25 dB 20 to 20,480 Hz
 at zero setting.
 THD: Less than .05% at 1 volt.
 SIGNAL-TO-NOISE: Better than 90 dB.
 INDIVIDUAL OCTAVE-CONTROL RANGE: Minimum
 ± 12 dB (Typ. ± 14 dB), each octave centered at 30,
 60, 120, 240, 480, 960, 1920, 3840, 7680, and
 15,360 Hz.

CIRCLE SERVICE CARD # OR WRITE TO:
SOUNDCRAFTSMEN
 1721 NEWPORT CIRCLE, SANTA ANA, CA 92705

db letters

index of advertisers

THE EDITOR:

In my article, "Digital/Analog Level Control," in db's September issue, the address zip code for Analog Devices is incorrect. The correct address of the firm is: Analog Devices, P.O. Box 280, Norwood, Mass. 02062.

WALTER JUNG

THE EDITOR:

In Robert Faulkner's article, "A Neat Little Dual Limiter," in the August issue, there appears to be a printing error in Figure 1. The 2N3053 has no bias to turn it on. Also, I wonder if Mr. Faulkner has given any thought to making the circuit into a compressor by changing the type of light-dependent resistors for a different attack and release time and the gain of the 377 for differing slopes.

HENRY L. BROOKS
 Los Gatos, Ca.

Mr. Faulkner replies:

I had not considered making the attack and release time variable. My thinking was that there are too many knobs in this industry already. However, you may have a point.

I guess I went through every light-dependent resistor known to man and decided on the 704L-2 because it had a very fast attack time and a reasonable release time—three seconds for 75 per cent recovery. Also, the 704L-2 had the most linear response, which is important in this configuration.

The 2N3053 does not have a bias resistor to turn it on because it is not used as an amplifier. It becomes a variable resistor the way it is connected and therefore controls the brightness of the led.

ROBERT R. FAULKNER

Ashley Audio	19
Audio Designs & Mfg.	15
Audio-Technica	13
BGW	11
Cetec Audio	23
Daycom	26
Electro-Voice	6
ESE	24
Garner Industries	14, 16
Jensen Tools	21
JBL	7
The London Company	18
Micmix	29
Modular Audio	12
Otari Corporation	Cover 3, 27
Recording Supply Corporation	14
Robins-Fairchild	4
Sennheiser	28
Sescom	16, 19
Shure Brothers	Cover 2
Soundcraft Electronics	5
Soundcraftsmen	2
Sound Technology	9
Sound Workshop	25
Standard Tape Labs	8
Willi Studer America	23
Telex	3
Tentel	26
Uni-Sync	12
White Instruments	10
Yamaha	Cover 4

db sales offices

THE SOUND ENGINEERING MAGAZINE

New York
 1120 Old Country Rd.
 Plainview, N.Y. 11803 516-433-6530

Roy McDonald Associates, Inc.
Dallas
 Stemmons Tower West, Suite 714
 Dallas, Texas 75207 214-637-2444

Denver
 3540 South Poplar St.
 Denver, Colo. 80237 303-758-3325

Houston
 3130 Southwest Freeway
 Houston, Tex. 77006 713-529-6711

Los Angeles
 500 S. Virgil, Suite 360
 Los Angeles, Cal. 90020 213-381-6106

Portland
 2035 S. W. 58th Ave.
 Portland, Ore. 97221 503-292-8521

San Francisco
 Suite 265, 5801 Christie Ave.
 Emeryville, Cal. 94608 415-653-2122

Copies of db

Copies of all issues of db—The Sound Engineering Magazine starting with the November 1967 issue are now available on 35 mm. microfilm. For further information or to place your order please write directly to:

University Microfilm, Inc.
 300 North Zeeb Road
 Ann Arbor, Michigan 48106

Old-New Reel Time Recorder

Telex/Magnecord series 1400 broadcast quality recorder/reproducer. An old name that spells reliability. A new design for today's state of the art.

- The Old. Telex/Magnecord products are still made in the USA so parts and service are always available. The series 1400 is still built on a solid die cast aluminum main frame for reliable operation around the clock. It's still available in full, half and

quarter track configurations, has fail safe differential brakes and accepts 8 1/4 inch reels. It also still comes with three motors—but then, that's touching on the new.

- The New. A brushless d.c. servo drive with a crystal oscillator control reference so accurate it virtually eliminates program timing errors. New, three speeds: 3 3/4 - 7 1/2 - 15 ips. New catenary head block for straight tape loading, the convenience of one hand cueing and the bi-level illumination of push button controls. New DTL logic controls eliminate EMI and provide fast, spill

proof tape handling gentle enough for half mil tape. And new electronics, clean to 60 dB S/N at all speeds.

- If you're looking for a real time, reel recorder with old name reliability but designed for today's demands, you'll find it in the Telex/Magnecord series 1400. For complete information please write:



PRODUCTS OF SOUND RESEARCH

TELEX
COMMUNICATIONS, INC.

9600 ALDRICH AVE. SO. • MINNEAPOLIS, MINN. 55420 U.S.A.
Europe: 22, rue de 1a Legion-d'Honneur. 93200 St. Denis, France
Canada: Telak Electronics, Ltd., Scarborough, Ontario

Circle 17 on Reader Service Card



Those familiar with the E-V Sentry series may perhaps note that the original entries in this series, the I and II (their current variants being the IA and IIA), are approaching a twentieth anniversary. These venerable systems have served a generation of professional users, providing listenable and reasonably smooth acoustic output with medium efficiency, medium size, and a moderate price tag.

Those familiar with E-V design philosophy during the last five years may also note a special interest in the application of carefully researched vented system design (à la A. N. Thiele) to new E-V products. It was natural to re-examine the basic design goals of the smallest members of the Sentry line and consider how greater value could be offered, based upon new and refined knowledge relating to system design.

Applying considerable thought to this system with its half-watt midband output (which separates the system output potential from most home-oriented "bookshelf" systems by at least 6 dB) resulted in several alterations felt to be of value. These are: a) smaller, more convenient size (nearly 1/2 that of the original systems) for the same performance; b) more uniform power output in the two octaves above 1000 Hz (accomplished through the use of new drivers); c) an option to "step down" the low frequency capabilities from the original 50 Hz to about 32 Hz with minor penalties; d) more attractive appearance; and e) closer sonic resemblance to more recent Sentry designs.

The Sentry V offers a midband efficiency level of approximately 2% and approaches the general performance of the Sentry III system to a surprising degree at a fraction of its cost. As in the case of the Sentry III, it is expected that more than a few of these systems will find their way into home as well as small studio applications when more than usual sound pressure levels are required without sacrifice in sonic quality.

Electro-Voice®
a gulton company

Dept. 1163BD, 686 Cecil Street
Buchanan, Michigan 49107

Circle 29 on Reader Service Card

News Room Audio

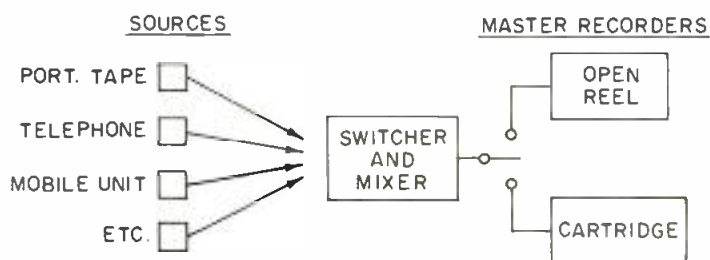

Fig. 1. When a variety of sources must be channeled to one or more master recorders, some type of switching and mixing unit is needed.

● Many electronic means are used for gathering and editing the news presented by radio stations. Most of the effort ends up on audio tape for air presentation over the station's regular facilities. The news room is actually a specialized, but major, recording facility of the station. Although the bulk of news programming is talk in nature, the technical quality of the finished product should be comparable to that offered by the station's other facilities.

BASIC PROBLEMS

When a variety of sources must be channeled into a master recorder, some means of switching and mixing is desirable. A standard console can be used for the purpose, or (as is often the case), the station can design its own arrangement. Whatever method is used, impedance matching of the various equipment units, and signal levels throughout the system must be considered.

The input/output impedances of

each unit are some of the basic design parameters which allow various units to electrically interface. Impedances

MOVING?

Keep db coming
without interruption!

Send in your
new address promptly.

Enclose your old
db mailing label, too.

Write to:

Eloise Beach, Circ. Mgr.
db Magazine
1120 Old Country Rd.
Plainview, N.Y. 11803



Introducing The Ice Cube.

It can go all day and all night and still keep its cool. Here's why:

One, there's a super quiet, thermally activated two-speed fan that runs low most of the time, but kicks into high when the going gets hot. (And, at a short 5¼" tall, The Ice Cube is perfect for stacking.)

Two, there's an absolutely exclusive 2000-watt solid-state inverter power supply instead of those massive transformers you're used to. Total weight: 35 pounds!

There's more. 300 watts RMS per channel, both channels driven into four ohms from 20Hz to 20 KHz, at .05% or less total harmonic distortion.

Color-coded peak reading lights step up and down so you're the first to know if it's clipping.

Go see The Ice Cube. Its formal name is the JBL 6233 Professional Power Amplifier. Bring \$1500 and it's yours.

Circle 33 on Reader Service Card

www.americanradiohistory.com

JBL

should be matched properly so the most efficient transfer of the signal from one unit to another can be accomplished. When units are connected together without consideration for impedance matching, then a serious mismatch can occur, affecting both signal levels and audio frequency response.

Signal amplitudes are important both from an operational as well as a technical standpoint. In operation, if the levels are at great variance with each other, the operator will have a difficult time editing and recording master tapes. If levels are too high, amplifiers may be overloaded and distortion results. When levels are too low, then there is the chance of cross-

talk, noise, and interference problems.

HEADROOM

Signal levels and distortion often go hand in glove together. One way that distortion can occur is through lack of *headroom* in the equipment design. True signal peaks are not indicated on the vu meter; they can be 8 to 10 dB higher than the indicated peaks. Headroom is that region above the indicated signal peaks and the point the amplifier goes into distortion.

You can check out the headroom in the equipment or system with a sine wave audio signal and a distortion analyzer. Feed the tone into the input of the system and adjust controls for normal operating levels. Measure distortion at the output of the system. Without changing any of the adjustments, increase the output of the signal generator by 10 dB and again measure distortion. If there is no change

in the measured distortion, then there is adequate headroom in the equipment. But if the distortion increases significantly, headroom is lacking. In this case, set normal operating levels *downward* to a new value for normal operating levels. This should be at least 10 dB below the point where the amplifier or system goes into distortion. One word of caution: either pad the vu meter or disconnect it during the high level test to prevent damage.

PADS AND TRANSFORMERS

Match impedances and control signal levels throughout the system by use of resistor pads or transformers. Precision pads may be purchased, but home made pads are usually adequate. The resistor values for the pads may be calculated from formulas found in many technical books or, oftentimes, equipment manufacturer catalogs will provide tables of resistor values for

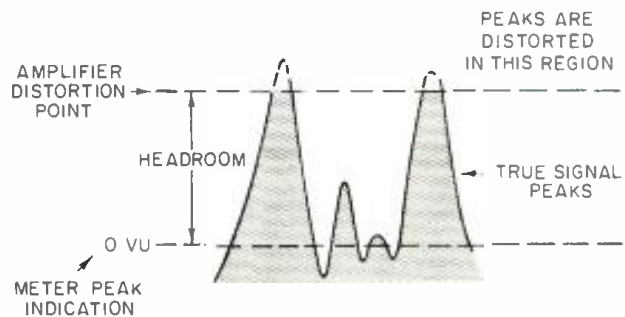

Figure 2. Headroom is the space above the signal peaks, as indicated on the vu meter and the point the amplifier begins to distort.

You're in Good Company

when you use STL magnetic Test Tapes

STL magnetic test tapes are widely used by major recording studios, equipment manufacturers, government and educational agencies throughout the world. The most comprehensive test tapes made they are offered in 1" and 2" sizes as well as flutter tapes and all other formats.

You *know* your system is in step with the rest of the industry, compatible and interchangeable, when you employ STL tapes, the most accurate reference available.

Write for a free brochure and the dealer in your area.

Distributed exclusively by Taber Manufacturing & Engineering Co.



STANDARD TAPE LABORATORY, Inc.

2081 Edison Avenue
San Leandro, CA 94577
(415) 635-3805

building pads. These are calculated values and may not always match up with standard stock resistor values. So, select stock values close to the required values. This will affect the end results by a few dB, but otherwise they will be satisfactory.

Transformers can be used for isolation, matching, or bridging. Good quality audio transformers are somewhat expensive, so you may desire to stick with resistors to do the job. But remember that resistors always create a loss when placed in the circuit, so the equipment should have enough reserve capacity to make up for this loss. When isolation is a definite need, it's best to use a transformer.

HEAD ALIGNMENT

Recorder heads, especially those on the master recorders, should be kept in proper alignment. Use a standard NAB alignment tape for the playback alignment first. Then align the recorder with audio tones from a signal generator using a good tape to record the results. It is not enough to obtain good results on the master machine alone. Take the tape you just recorded with tones to one of the control room machines and play it back. The results produced should be very similar to

Here's how useful a distortion analyzer can be

Monitor voltage, power, distortion or dB ratio.

No manual nulling controls required (the 1710A is always in auto-null, reaches a null in less than 5 seconds).

Intermodulation Distortion Analyzer optionally available.

Oscillator distortion is typically .001%.

Measure generator signal at load with the push of a button.

± 1 dB Vernier adds fine level control.

Selectable 18 dB per octave filters reject hum and high frequency noise.

Internal oscillator adjustable from +26 dBm to -89.9 dBm in 0.1 dB steps.

Fast pushbutton operation lets you set level, measure voltage or power, then measure distortion.

Turn off oscillator for quick S/N measurement.

Measure voltage or power from 10 Hz to 110 kHz.

Tuning indicators help measure distortion of an external source.

100 k Ω Balanced Input.

Simultaneously select oscillator and analyzer frequency with fast-to-use pushbuttons. 10 Hz to 110 kHz.

View input signal on a scope.

Automatic Set Level is optionally available.

View distortion products on a scope.

Measure distortion down to .002%, voltage or S/N ratios with 100 dB dynamic range.

Balanced and floating 150 Ω or 600 Ω Generator output.

Two of the above features are so outstandingly valuable that we especially invite your attention to them.

One is the fast, easy measuring you get with pushbutton-selected distortion-measuring circuits (signal source and measuring circuits are simultaneously selected with the **same** pushbuttons). Pushbuttons make it so simple to measure quickly and to repeat measurements.

Secondly, you can drive virtually any type of circuit from the signal source output — whether

balanced, unbalanced, off-ground or whatever. That's because the signal source output circuit is fully **isolated and balanced**.

There is no output transformer to introduce noise or distortion.

Besides these outstanding conveniences, you can have the Sound Tech 1710A with an option that enables you to measure **intermodulation distortion**.

Call Mike Hogue/Larry Maguire to get full information on an instrument recognized everywhere as the standard of the audio field.

ST[®] **SOUND TECHNOLOGY**
1400 DELL AVENUE
CAMPBELL, CALIFORNIA 95008
(408) 378-6540

Circle 39 on Reader Service Card

Figure 3. If the amplifier or system does not have adequate headroom at the prescribed normal program levels, then set a new operating level at least 10 dB below the amplifier distortion point.

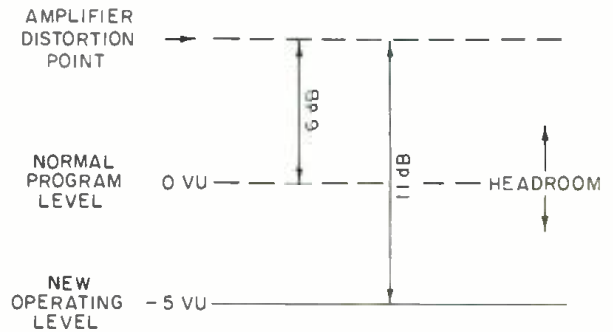
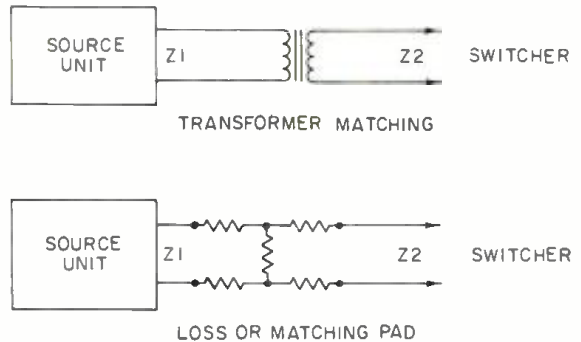

Figure 4. Impedances should be matched and signal levels controlled with either pads or transformers.



those obtained on the master machine by itself. If there is a great variance, go back and realign the master machine again. Make sure the playback equalizer in the master machine is not

overcompensating for poor head alignment. Unless the recordings are compatible, the quality will suffer when the control room machines play the recorded product on the air.

CLEANING

All the news tape machines, especially the master recorders, should be cleaned on a regular basis. Clean the heads, pinch rollers, drive shaft and guides. A main problem can be caused by oxide from the tape that builds up on the head, forming ridges that prevent the tape from making tight contact with the face of the head. It is not possible to get a good recording unless there is a tight head-to-tape contact. The results will be low signal levels and poor audio frequency response.

Another problem can be iron oxide from the tape, clogging the gap between the pole pieces of the head. This will produce a magnetic short circuit to the flux lines of the head, making an easy deflected path for the flux instead of it going through the coating on the tape. (The gap is air or other non-magnetic insulation which has a high resistance to the flux lines. As the tape passes against the face of the head in tight contact, the iron oxide on the tape creates a low resistance path so the flux lines flow into the tape and thus magnetize the iron particles—the desired result of the recording.)

Also, oxide coating can harden on the head, guides and other spots where there is friction with the tape, producing a very abrasive surface that will scratch and wear out the tape quickly. If small sections of loose tape wrap around the pinch roller or capstan drive shaft, this will increase their diameters and change the tape speed.

NEW AUDIO SPECTRUM MONITOR!
1/3 OCTAVE REAL TIME ANALYSIS MODEL 142

FEATURES

- PEAK READING • TWO MEMORIES: CUMULATIVE OR SAMPLE • VARIABLE TIME CONSTANTS (0.1 - 2 SEC.) • CALIBRATED IN DBM • 10-20-30 DB DISPLAY RANGE • 40 HZ to 16 KHZ ON 1/3 OCTAVE ISO CENTERS • 11 x 28 LED ARRAY • BUILT-IN PINK NOISE SOURCE • 3 1/2" x 8" DEEP RACK MOUNT.

USES

- PROGRAM MATERIAL MONITORING • RECORDING AND MIX-DOWN ANALYSIS • PORTABLE SYSTEM ADJUSTMENT • TAPE EQUALIZATION AND CALIBRATION • TRANSMISSION LINE EQUALIZATION • BEFORE-AFTER COMPARISONS • FREQUENCY RESPONSE TESTING



Suggested List Price \$3200

ALSO: Active and passive equalizers • Other real time analyzers
 Dealer inquiries invited

White

Call or write today: WHITE INSTRUMENTS, INC.
 P.O. BOX 698 512/892-0752 Austin, Texas 78767

Circle 14 on Reader Service Card

50,000 Miles Parts & Labor.



BGW
SYSTEMS

Heavy-Duty Amplifier
Model 5000

Heavy-Duty Amplifier
Model 5000

Tear us apart. Modularly.
We think we're realistic. Despite the rugged and proven design of our amps, we're not perfect. Sometimes they need attention like anybody else's.

This ad is not about performance. We know you've accepted us as the company with the most to offer...more studios and music people seem to be making The Big Decision to switch their power amplifier needs to us.



Setting our better performance aside, a big difference between us and the others is our ease of servicing. Although our three year parts and labor warranty is not unique, our modular design that allows rapid and easy component changeout is. After the 50,000 miles on the road

or the equivalent run of tape in the studio, we survive longer because you can keep us around without a lot of hassles.

A BGW amp is a practical, austere looking piece of gear for good reason. In an environment where only the strong survive, you'll be seeing more austere BGW front panels. 50,000 miles later, if the parts and labor are needed, tear us apart, modularly.

Get our information on a full line of power amps and find out why more roadies are lugging our heavy amps and studio engineers love us.



B.G.W. SYSTEMS
13130 South Yukon Ave.
Hawthorne, CA 90250
(213) 973-8090

Circle 18 on Reader Service Card

What's new from MAP?

DISTRIBUTION AMPLIFIER

MODEL 4820



- Bridging (6K ohms), Balanced, Transformerless (Differential) Input Configuration
- 8 Balanced, Transformerless Outputs (Precision Resistor Network)
- Continuously Adjustable Gain, Up to +10 dB
- Low Noise (Output) -90 dBm
- Low Distortion (Typ. 0.1%)
- High Output Level, +20 dBm per channel
- 80 dB of isolation between Outputs & Output to Input

For prompt assistance call or write Rick Belmont.



Manufacturers of ■ CONSOLES
■ CONSOLE/SYSTEM COMPONENTS

MODULAR AUDIO PRODUCTS, Inc.

A UNIT OF MODULAR DEVICES, INC.

1385 Lakeland Ave., Airport International Plaza
Bohemia, New York 11716 516-567-9520

Circle 32 on Reader Service Card

broadcast sound (cont.)

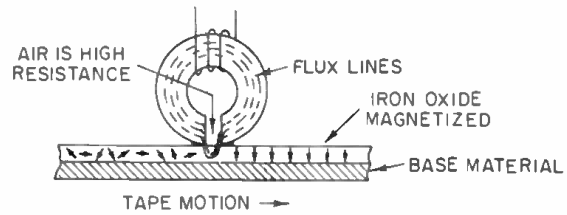

(A)

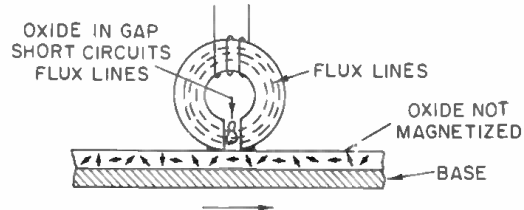

(B)

Figure 5. (A) The air gap has a high resistance to magnetic flux lines of the head and forces them through the easier path in the tape's iron oxide. (B) When oxide clogs the gap, the flux lines are short-circuited and few, if any, enter the tape.

Regular cleaning of all the machines will do much to maintain the technical quality of the end product.

TAPE

All audio tape is not alike even though it may visually appear the same. Various types of tape (not necessarily brands) have other differences besides thickness of the base material. The iron oxide coating differs. This is where the action is—at the iron oxide coating. The recorder should be optimized by adjusting the bias for the highest output and frequency response on a particular type of tape. If possible, the news room should standardize on one type. If there must be several types in use regularly, a compromise is necessary. Find a compromise setting of the bias and equalizers that will produce similar, but satisfactory results on all the types of tape in use. Remember that this is a compromise and therefore less than optimum, but it is better than having optimized results on one type and much less than optimum on all the other types. However, your best bet is to standardize on one type of tape.

BULK ERASING

Cartridges must be bulk erased, but it is often also advantageous to bulk erase small open reel tapes that will be taken out on portable recorders.

TROUPER SERIES



The Trouper Series — Permanent Yet Portable

You're looking for a live music mixer to fit your budget, yet performs like a million bucks. It's got to meet your specifications but you don't have a fortune to spend. Look at the Trouper Series. You can start small and add on at any time. We've got a wide variety of expandable mixers, and a complete selection of accessory packages, direct boxes, mic splitters and more. Our equipment bolts and plugs together making it the most flexible, and completely customizable mixing system available today. So whether you've got a fortune to spend or not, check out the Trouper Series — We've got a sound for you. Write for catalog.



DESIGNERS & MANUFACTURERS OF PROFESSIONAL AUDIO SYSTEMS & EQUIPMENT
5559 CAHUENGA BLVD / NORTH HOLLYWOOD, CALIFORNIA 91601 / (213) 985-9501

Circle 30 on Reader Service Card

The phono cartridge that doesn't compromise any modern record.

AT15Sa



Choosing an AT15Sa can add more listening pleasure per dollar than almost anything else in your hi-fi system. First, because it is one of our UNIVERSAL phono cartridges. Ideally suited for every record of today: mono, stereo, matrix or discrete 4-channel. And look at what you get.

Uniform response from 5 to 45,000 Hz. Proof of audible performance is on an individually-run curve, packed with every cartridge.

Stereo separation is outstanding. Not only at 1 kHz (where everyone is pretty good) but also at 10 kHz and above (where others fail). It's a result of our exclusive Dual Magnet* design that uses an individual low-mass magnet for each side of the record groove. Logical, simple and very effective.

Now, add up the benefits of a genuine Shibata stylus. It's truly the stylus of the future, and a major improvement over any elliptical stylus. The AT15Sa can track the highest recorded frequencies with ease, works in

*TM. U.S. Patent Nos. 3,720,796 and 3,761,647.

any good tone arm or player at reasonable settings (1-2 grams), yet sharply reduces record wear. Even compared to ellipticals tracking at a fraction of a gram. Your records will last longer, sound better.



Stress analysis photos show concentrated high pressure with elliptical stylus (left), reduced pressure, less groove distortion with Shibata stylus (right).

The AT15Sa even helps improve the sound of old, worn records. Because the Shibata stylus uses parts of the groove wall probably untouched by other elliptical or spherical styli. And the AT15Sa Shibata stylus is mounted on a thin-wall tapered tube, using a nude square-shank mounting. The result is less mass and greater precision than with common round-shank styli. It all adds up to lower distortion and smoother response. Differences you can hear on every record you play.

Don't choose a cartridge by name or price alone. Listen. With all kinds of records. Then choose. The AT15Sa UNIVERSAL Audio-Technica cartridge. Anything less is a compromise.

These machines are half-track and there may be occasions when an important story is brought back to the station with no time to dub it over on the master machine. The tape can be played directly on the control room machines (assuming it was run at the correct speed). Since most control room machines are full track, the half-track tape you are using must have the other track blank.

When bulk erasing tape, move the tape out of the eraser field before turning the eraser off. That strong collapsing field can severely magnetize the tape, creating a clicking or popping in the background of new recordings on that tape, something difficult to erase.

BATTERIES

Portable recorders will operate on batteries, usually the rechargeable type. It is important that the batteries be kept at full charge so the recorder is ready to use. If the batteries are down and the recorder taken out on assignment, an important interview may be lost because the batteries went dead. If they're not quite dead, just low enough so that the machine runs at a slow speed, when the tape is played back on a machine that is up to full speed, the results will be "Donald Duck" sounds. If the tape is open reel, it is sometimes possible to save the recording, provided that there is a machine which has a variable speed arrangement, such as a variable cue speed. Play the tape and adjust the speed control until the voice sounds natural. Once you can achieve this, then dub the results onto another tape, rather than rely on this arrangement. The best practice, of course, is a regular check on the batteries and the chargers.

TELCO RECORDING

Many interviews are done over the regular telephone, and the interview recorded. To get the best recording, connect directly to the telephone line for that phone number. But use 0.1 μ Fd capacitors in each side of the line for d.c. isolation and an audio transformer for a.c. isolation to prevent hum. Voice levels at the news room and the far end of the line will almost always have a wide difference. Use of a gated age amplifier in the lineup will improve the recordings considerably to equalize the voice levels.

SUMMARY

The news room is a specialized, but important recording center of the station. Good technical quality requires attention to the impedances and signal levels in the mixing arrangement, and then a regular cleaning and maintenance program of the equipment. ■

audio-technica 

INNOVATION □ PRECISION □ INTEGRITY

AUDIO-TECHNICA U.S., INC., Dept.1168D, 33 Shiawassee Ave., Fairlawn, Ohio 44313

Erase faster



Erase cleaner



Erase easier



Garner Erasers cut man-hours spent erasing audio and video tapes. Simple, safe continuous belt operation gives you "hands-off" professional erasures in only four seconds. Handles up to 10½" reels, cartridges, and cassettes. Acclaimed by major users, yet priced low enough for the smallest studio or station to afford.



GARNER INDUSTRIES

4200 N. 48th St.
Lincoln, NE 68504
402-464-5911

Circle 31 on Reader Service Card

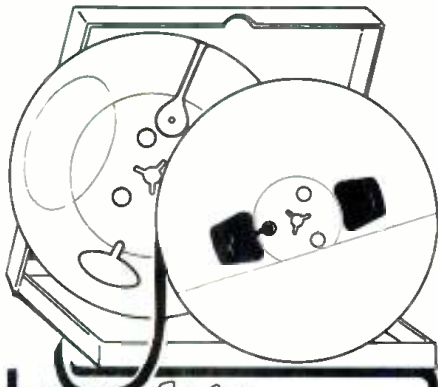

complete supplies for reel to reel audio recording

- TAPE** AMPEX and Scotch all professional grades on reels or on hubs
- EMPTY REELS** all sizes, widths and hub types
- BOXES** for all reels, in various colors
- LEADER-, TIMING- & SPLICING TAPES**

Top Quality Competitive Pricing
Immediate Shipment
Call or Write for Details/Prices



recording supply corp.
1291 RAND RD -DES PLAINES, IL 60016
312/297-0955

Circle 34 on Reader Service Card

db theory & practice

NORMAN H. CROWHURST

• The theory of a crossover is that at its design frequency both units will receive precisely 3 dB less signal than they receive in their pass range, so that each delivers exactly half the power at that frequency. As we have been saying, that theory is based on the assumption that the loudspeaker has an impedance that looks like a pure resistance, to receive that half of the power.

Whatever may be the situation with the unit that receives the high-pass output, the one that receives the low-pass output usually has an inductive impedance at this frequency. In the August issue, I showed that a low frequency (woofer) unit has an impedance that can be approximated as a combination of resistance and inductance. So you count the inductance as part of the crossover filter you design. That is the idea.

WOOFER INDUCTANCE

But to do that, you need to know the equivalent inductance of the woofer unit. How do you arrive at that? I have heard engineers argue that the value is the voice coil inductance of the unit. So they clamp the voice coil to stop it from moving and measure its inductance.

That might work out, if that was the way you operated your loudspeaker. But the speaker doesn't radiate very much sound with its voice coil clamped! You need to know the inductance component when the unit is working, in exactly the situation it will be when the whole system is operating.

As I said before, part of the equivalent inductance is due to the actual voice coil inductance and part of it is due to mass effects of the moving cone, and of air that the cone pushes around. Radiated energy appears principally as resistance, which adds to the voice coil resistance.

So how do you measure the effective

inductive and resistive components, and at what frequency do you take them? The answer to the last part of that question should be obvious: at crossover. But a surprising number of people will use an a.c. bridge, which has its own built-in frequency, meaning that they measure it at that frequency, thus assuming that the values are constant, which they seldom are.

Anyway, you probably do not need a value as precise as one that a bridge can give you. So using a bridge to measure the unit's inductance will give you a value that is unnecessarily precise and, more importantly, wrong for the purpose you have in mind, unless the bridge measurement frequency just happens to be the same as the crossover you plan to use.

With a little care in calibration, those same ellipses I introduced to you in the last column can tell you what you want to know in order to design an appropriate crossover filter.

TESTING

First, you should make the test with the unit in position and, if possible, with the unit that takes high pass drive also connected. Be careful to measure only the impedance of the low-pass fed unit (FIGURE 1). This will produce a loading on the low-pass unit equivalent to what will exist when your design is complete. You may want to try reversing connections to the high-frequency unit to make sure the phasing is correct at crossover frequency.

To take your readings on the 'scope, use as small a resistor as possible in series, to measure current, that will give you an adequate horizontal deflection—not more than 1 ohm. You want the electrical damping of the unit to be as near operating value as possible.

You calibrate the vertical and horizontal scales in a conventional way so you know what they mean in voltage

Fig. 1. Schematic for oscilloscope set-up for measuring impedance of low-frequency unit of a crossover pair, with both units being driven in frequencies within range of crossover frequency to be chosen.

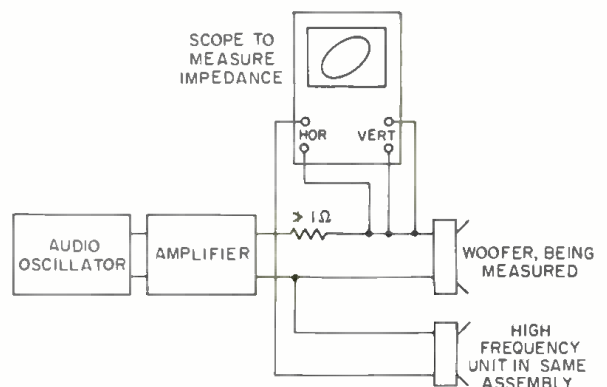

NOW! See what you hear

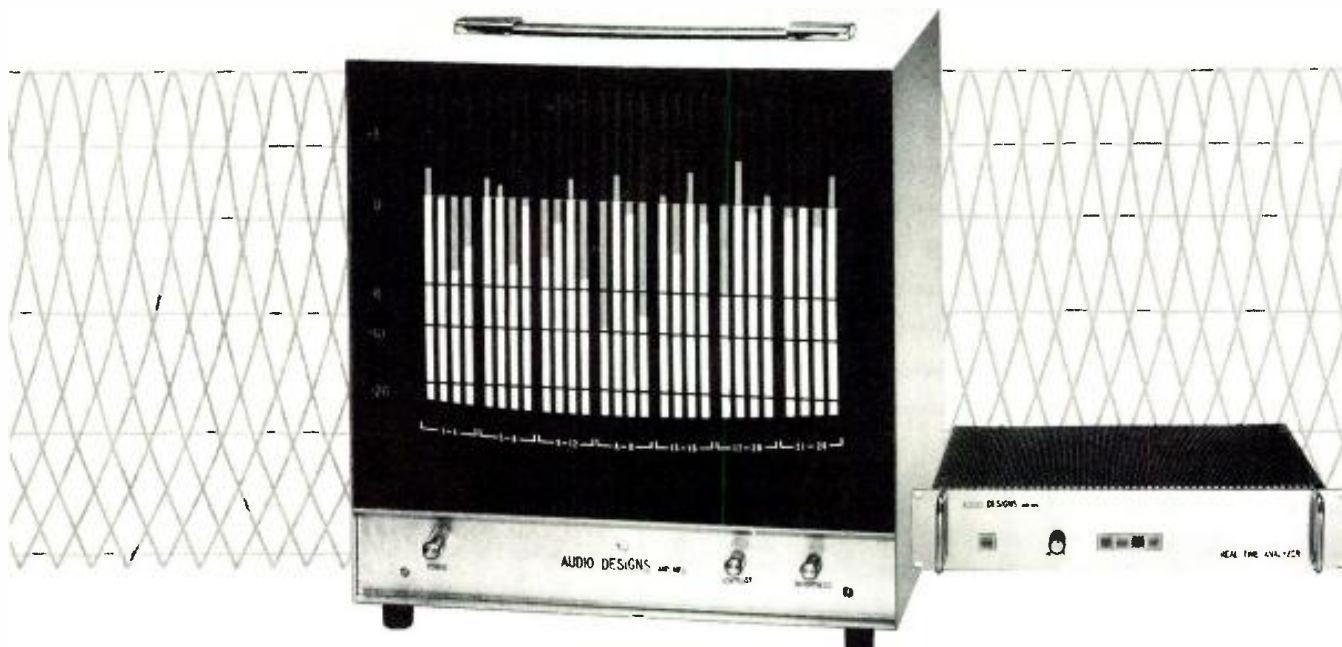

ADM[®] 660

Audio Spectrum Analyzer for Recording • Mixdown • Broadcasting Mastering • Maintenance • Audio Testing

FEATURES

- Higher resolution and visibility than available LED displays.
- Divides 40 Hz to 20 kHz spectrum into 28 third octave filters that are displayed on a TV monitor screen as 28 individual bars, allowing constant monitoring of audio frequency spectrum.
- Dynamic range of 25 dB with 1/4 dB resolution. Accepts signals from 1 MV to 10 V RMS.
- Screens from 12" to 23".
- Low cost. Compact.

APPLICATIONS

- Facilitates disc mastering.
- Precise monitoring of program material.
- Exact evaluation of apparent loudness curve.
- Frequency response tests.

ALSO AVAILABLE

Unique 28 channel Vue-Scan designed for operation with ADM 660. Same display screen can be used for both units.

LET'S SEE WHAT
AUDIO DESIGNS[®]
CAN DO FOR YOU.

Call collect, or write



AUDIO DESIGNS AND MANUFACTURING, INC.

16005 Sturgeon, Roseville, Michigan 48066
Phone: (313) 778-8400, Cable: AUDEX
TLX-23-1114

AMPEX DISTRIBUTED OUTSIDE U.S.A.
BY AMPEX INTERNATIONAL OPERATIONS, INC.

Circle 36 on Reader Service Card

Dub faster



Dub easier

Garner Model 1056 updates your dubbing operation. Five 1200' professional copies in four minutes. Threads fast. Rewinds in 60 seconds. Single capstan drive and solid state electronics guarantee unvarying high quality. Priced low enough for quick payout. Write for brochure and names of users.



GARNER INDUSTRIES
4200 North 48th St.
Lincoln, NE 68504
Phone 402-464-5911

Circle 40 on Reader Service Card

INTRODUCING

A NEW AUDIO CONNECTOR

MODEL: PM-3

FEATURES:



1. Gold contacts
2. Ground lug
3. Mounting holes designed for 1/8 pop-rivets
4. Special non-reflecting finish
5. Economical
6. Compatible w/XL's

INTRODUCTORY PRICE OFFER*

	50	100	500	1M	10M
	\$1.00	.82	.78	.74	.67

... SOLD IN LOTS OF 50 ONLY ...
TERMS 5% Discount Cash with order, or COD only, FOB Delivered



(800) 421-1828, (213) 770-3510
TWX 910 346-7023
P.O. Box 690 GARDENA, CA 90247

* OFFER GOOD IN USA ONLY and EXPIRES JANUARY 31, 1977

Circle 24 on Reader Service Card

theory & practice (cont.)

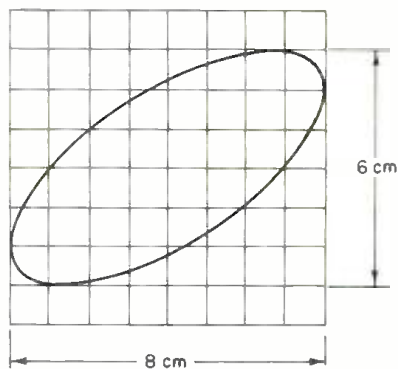

Fig. 2. Typical ellipse obtained to use as measure of magnitude of impedance, showing relevant measures for this purpose.

and current, respectively. Then the width and height of the ellipse will give you the impedance magnitude and the shape of the ellipse will tell you its phase.

This is how you do it. Suppose, with the gain of both deflections calibrated, the width is 8 cm. and the height is 6 cm. The horizontal gain is set at 10 millivolts per centimeter, and your series resistance is 1 ohm.

8 cm. represents 80 millivolts across the 1 ohm, or 80 milliamps. If the vertical gain is set for 0.5 volt per centimeter, 6 cm. represents 3 volts. Both those values are peak-to-peak, by the way, so you do not need to convert them to rms because the ratios will be the same.

The impedance represented by this trace is one that will pass 80 milliamps with 3 volts across it, which figures to $3 \div 0.08 = 37.5$ ohms. Now, to measure phase, you will find it easier to set the gain so height equals width. This will lose your calibration for impedance magnitude, but you already have that.

If the ellipse is skinny, the easiest way to figure phase is to take the intercepts on the axes (FIGURE 3). If you have set both height and width to 8 cm., and the average intercept on the axes is 1.5 cm. from the center of the grid, the sine of the phase angle is $1.5 \div 4 = 0.375$. A table, or your pocket computer, will give the angle at 22 degrees.

Now, the resistance component is 37.5 ohms, times $\cos 22$ degrees, which figures to 34.77 ohms. The reactance component is 37.5 ohms, times $\sin 22$ degrees, which figures to about 5.27 ohms. Now, what you want is inductance, so you apply the formula $X_L = \omega L$, or $L = X_L \div \omega$, where ω is $2\pi f$.

With a frequency of 800 hertz, ω is $6.28 \times 800 = 5024$. And 5.27 ohms

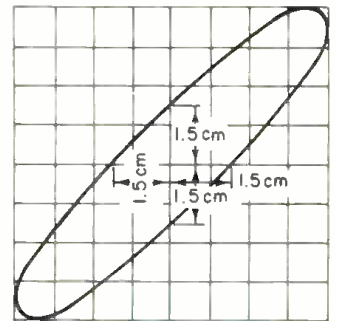

Fig. 3. Typical measurement of phase on a relatively narrow ellipse.

divided by 5.024 makes about 1.05 millihenries.

If the ellipse is broad, the easier way is to see how far from the axes the ellipse makes a tangent with the top, bottom and sides (FIGURE 4). This will give the cosine of the angle. If it is 1.5 cm. again, the cosine is 0.375, leading to the 68 degree angle, from which point the method will be the same, although the values will be different.

That method will enable you to compute resistance and inductance at just one frequency at a time. If you compute it at a number of frequencies, all near to crossover frequency since that is where you are concerned with the value, you may find the value varies a little. This is because the equivalent circuit is not quite as simple as just one resistance and inductance combined.

PLOTTING ON GRAPH PAPER

Perhaps an even easier way, and one that is accurate enough for most purposes, is to plot the impedance on logarithmic graph paper (FIGURE 5.) I have shown a probable impedance curve in solid line against which I have drawn a dashed line that could represent a simple resistance and inductance combination, showing the construction.

You will want to operate your low frequency unit with a cut off below

Fig. 4. Typical measurement of phase on a relatively broad ellipse.

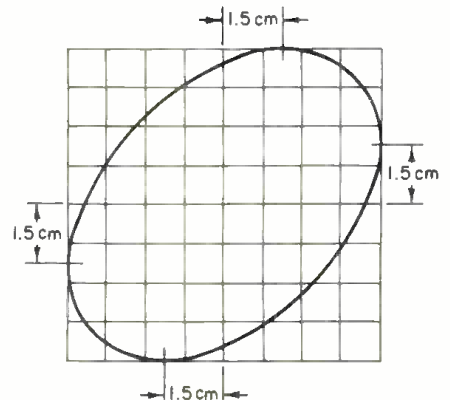

JUST PUBLISHED!

John Woram's

NEW BOOK FOR RECORDING ENGINEERS, TECHNICIANS AND AUDIOPHILES

The Recording Studio Handbook

Now off press and available at a special introductory price.

The technique of creative sound recording has never been more complex than it is today. The proliferation of new devices and techniques require the recording engineer to operate on a level of creativity somewhere between a technical superman and a virtuoso knob-twirler. This is a difficult and challenging road. But John Woram's new book will chart the way.

The Recording Studio Handbook is an indispensable guide. It is the audio industry's first complete handbook that deals with every important aspect of recording technology.

Here are the eighteen chapters:

- The Decibel
- Sound
- Microphone Design
- Microphone Technique
- Loudspeakers
- Echo and Reverberation
- Equalizers
- Compressors, Limiters and Expanders
- Flanging and Phasing
- Tape and Tape Recorder Fundamentals
- Magnetic Recording Tape
- The Tape Recorder
- Tape Recorder Alignment
- Noise and Noise Reduction Principles
- Studio Noise Reduction Systems
- The Modern Recording Studio Console
- The Recording Session
- The Mixdown Session

In addition, there is a 36-page glossary, a bibliography and five other valuable appendices.

John Woram is the former Eastern vice president of the Audio Engineering Society, and was a recording engineer at RCA and Chief Engineer at Vanguard Recording Society. He is now president of Woram Audio Associates.

This hard cover text has been selected by several universities for their audio training programs. With 496 pages and hundreds of illustrations, photographs and drawings, it is an absolutely indispensable tool for anyone interested in the current state of the recording art.

The regular price of *The Recording Studio Handbook* is \$35. For a limited time only—until November 31, 1976, we are offering this book at a special introductory price of \$27.50. To place your order, use the coupon below.

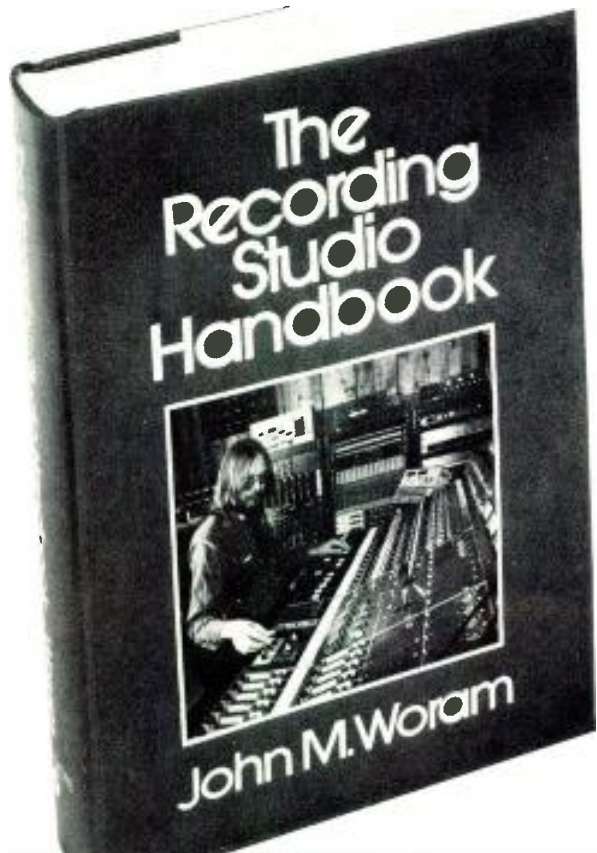

SAGAMORE PUBLISHING COMPANY, INC.
1120 Old Country Road, Plainview, N.Y. 11803

Yes! Please send ___ copies of *The Recording Studio Handbook* at \$27.50 each.

Name _____

Address _____

City/State/Zip _____

Total Amount _____

N.Y.S. Residents add 7% sales tax _____

Enclosed is check for \$ _____
Outside U.S.A. add \$2.00 for postage

Fig. 5. An example of how to estimate resistance and inductance directly from a plot of impedance against frequency, using log-log paper. Note the idealization necessary to make the computation.

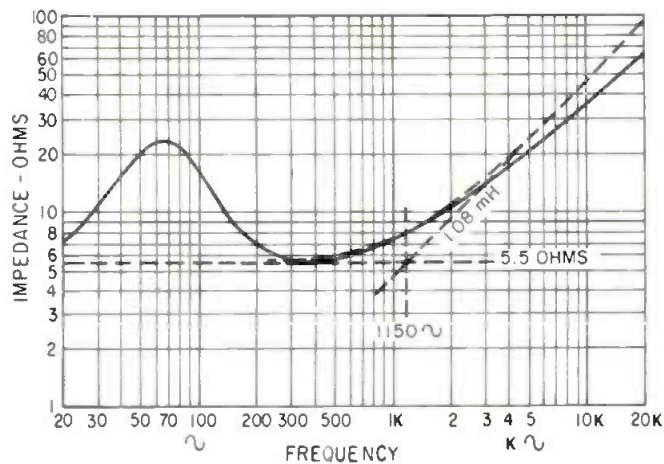

the point where its impedance, thus approximated by an ideal representation, is 1.414 times the resistance component. You can figure a workable value for the equivalent inductance from the frequency at which this 1.414 point occurs.

Suppose the best approximation of resistance is 5.5 ohms, and the frequency where the idealized impedance curve is 1.414 times 5.5, or 7.8 ohms (as nearly as you can read the graph), is 1,150~. The value for ω is 6.28 times this, or 7,222. Dividing 7.8 ohms by 7,222 gives 1.08 millihenries as the equivalent inductance.

A suitable crossover frequency would be anything below 1,000 hertz, al-

though not too far below.

Now, to complete a crossover design, you need to pick a configuration that has an inductance in the output lead of the low-pass section so that the loudspeaker's equivalent inductance can be part of it. Suppose the crossover design, for the impedance and frequency chosen, calls for 1.6 millihenries. Then you will use an actual value that makes it up, with whatever you figure the loudspeaker's inductance to be. If it was 1.08 millihenries, your inductor in the network needs to be $1.6 - 1.08 = 0.52$ millihenries, or 520 microhenries.

You should design your network for the resistive impedance of the

loudspeaker. If this is 5.5 ohms, then design your network for that value, for best results. It may be nominally an 8-ohm loudspeaker, and perhaps has values that straddle that nominal value throughout its pass range. The amplifier should use an 8-ohm output, that is, one designed to feed an 8-ohm speaker. Except near crossover, the network will pass the actual loudspeaker's impedance back to the amplifier, unchanged in value.

The amplifier may be a little mismatched at crossover frequency, but the filter will assure the correct shape of roll-off for the design chosen, that is, how many dB per octave you choose to use. ■

Complete Audio Distortion and Frequency Response ...Automatically

**RADIOMETER
COPENHAGEN**

Comprehensive distortion and frequency response measurements are easily performed with the BKF10 Automatic Distortion Analyzer. This unique instrument combines a distortion meter, a low distortion audio sweep oscillator (<0.01% t.h.d.) and an input/output ratio meter. Operation is totally automatic... No balancing, nulling or level setting is required. Addition of a recorder provides complete distortion and frequency response curves. Send for complete information.

THE LONDON COMPANY / 811 SHARON DRIVE / CLEVELAND, OHIO 44145 / (216) 871-8900

PARAMETRIC PRICE-PERFORMANCE *breakthrough*

\$599

SUGGESTED LIST PRICE



- true narrow-band (.05 oct.) through broad-band (3.3 oct.) equalization
- 50:1 frequency range, each band
- ± 15 dB eq. range, precise center "flat" position
- separate IN-OUT switch for each band
- ultra clean & quiet (-87 dBV noise, $< .05\%$ THD)
- internal power supply

At Ashly, we're definitely into Parametric Eq. We've used it extensively in our big SE series consoles for years. The SC-66 represents the culmination of these years of design, listening, and field testing. You can now have infinite control of all equalization characteristics at your fingertips with accuracy and resolution previously considered impossible. Check out an SC-66 at your pro-audio dealer.



ASHLY AUDIO INC.
1099 JAY ST.
ROCHESTER, N.Y. 14611
(716) 328-9560

Dealer inquiries invited

Circle 21 on Reader Service Card

Sescom's In Line Transformer

MODEL TR-122 AUDIO MIC-MATCHING TRANSFORMER



1. Flat frequency response ± 1 db 20-20KHz
2. Low distortion $< .3\%$ @ 30Hz -30db in
3. Locking ring on phone plug to reduce bad connections.
4. Mu-metal shielded to reduce hum.
5. Supplied with mating connector.

Pro Net: \$18.25

"Quality Engineered Sound Products"

SESCOM, INC

P.O. BOX 590, Gardena CA 90247 U.S.A.
(800) 421-1828 — (213) 770-3510

AVAILABLE IN STOCK FROM THESE PARTICIPATING DEALERS

CA: Gil Reyes Audio Concepts Inc. 7138 Santa Monica Blvd. Hollywood, CA 90046 (213) 851-7172	CT: Bob Dixon Fred Locke Pro Audio 62 Woodlawn Rd. Berlin, CT 06037 (203) 828-1124	NJ: Harry Stafford Tech Communications 1590 5th St. Trenton, NJ 08638 (609) 695-4509
Jerry or Shelley Coast Recording Equip. Supply 6114 Santa Monica Blvd. Hollywood, CA 90038 (213) 462-6058	M. B. Faulkner Audiotechniques, Inc. 142 Hamilton Ave. Stamford, CT 06902 (203) 359-2312	NY: Robert Manzo Harvey Radio Co. 23 W. 45th St. New York, NY 10036 (212) 575-5211
Jim Michaels Yale Radio Electric 6616 Sunset Blvd. Hollywood, CA 90028 (213) 465-3186	IL: Jerry Kollenburg Music Dealer Service 3210 N. Pulaski Chicago, IL 60641 (312) 282-8173	Frank Lannon Martin Audio 320 W. 46th St. New York, NY 10036 (212) 541-5900
Law Levin RPS Electronics — Sound Foyer 1521 S. Hill St. Los Angeles, CA 90015 (213) 747-7542	Dennis L. Sladek The Sound System 4348 W. 51 St. Chicago, IL 60632 (312) 581-7436	Paul Ash Sam Ash Music Stores Throughout New York (212) 347-7757
Ken Hyams Allied Communications Inc. 875 N. Palm Canyon Dr. Palm Springs, CA 92262 (714) 325-3028	MI: Henry J. Root Hy James Enterprises 712 Catherine Ann Arbor, MI 48104 (313) 994-0934	Marc Platt Comprehensive Service Corp. 18 West 81st St. New York, NY 10023 (212) 586-6161
Robert Budlong Zack Electronics 1444 Market St. San Francisco, CA 94102 (415) 626-1444	NC: Lee Butler Coliseum Sound Systems 4437 Beryl Rd. Raleigh, NC 27606 (919) 821-2222	OH: Stan Kozak Winteradio Co. 5373 Ridge Rd. Parma, OH 44129 (216) 886-5536

CANADA
Jim Bredon
John R. Tilton Ltd.
1900A Eglinton Ave. East
Scarborough, Ont. Canada
(416) 757-4171

ENGLAND
T. G. Blackham
Future Film Developments
90 Wardour St.
London, England W1V 3LE
01 437-1892

If there is no dealer in your area, use the factory-direct toll-free number.

Circle 19 on Reader Service Card

● In the past three columns, this department has discussed the different phases of putting on a presentation, from the technician's side. After the first column was written, this topic was discussed with an executive of a large company which made presentations regularly to employees, other executives of the company from overseas, and clients. Our friend suggested that it might be a good idea to discuss briefly in more detail a few of the more critical items that would help make a better setup, a more expedient operation, and a faster tear-down. Here are a few which were *not* mentioned in the previous columns, and one or two I did.

FILM PROJECTOR

First, a quick look at the film projector. The choice, in general, is between a manual load and an autoloader model. The decision depends to a great extent on the film to be shown, and how adept the projectionist is in handling an emergency. If the films are all on one reel, and the film can

be set up before the meeting gets under way, either projector can be used. With the manual type, the film can be threaded, focused, the sound level set, and run back to the beginning. With an autoloader, the front, or head end, must be clipped straight across to allow it to thread smoothly. Most projectors come with a cutter to take care of this. Once the film has begun to run, is focused, and the sound set, it, too, can be reset to the start. (With a manual projector, of course, the switch must be put back in the forward position.)

The problem of choice takes on a different appearance when one looks at the mechanics of the projectors. If the person running the films knows how to thread a manual projector easily and properly, there is no problem. If not, the film can come loose, lose a loop and flutter on the screen, or cause warbling sound. A good technician knows how to handle this problem. Normally, this won't happen if care is taken and the film tried before the show starts, but if there is a bad sprocket hole which doesn't show up until the first play begins, it might lose the loop. When this occurs, it is safer to stop the projector momentarily, fix the loop quickly, and resume. Some projectionists like to adjust the film while it is running, with a quick finger touch. This method is quicker, certainly, and looks better, but don't try it yourself unless you know what you're doing. Otherwise . . .

A problem could also arise if only half the film is played or if the film breaks in the middle. With a manual projector, the technician removes the film (provided he or she knows how) quickly, runs it past the break, adds a piece of tape to hook one end to the other after the sprockets, and continues the film. On an autoloader, this quick patchwork takes a bit more work. Since the machine is made for loading film automatically, the path is built to prevent the film from slipping out accidentally. It is this same safeguard that makes it more difficult to remove the film before the reel is finished.

A good technician might know to remove the cover over the exciter lamp, to open the sprocket covers, etc.—it just takes more time. When the film is spliced together, there are other complications. The autoloader machine is made to load from the front, and from the head end of the film. Quite a bit of know-how is necessary to re-

thread the machine manually. It might be easier to feed in the supply end and let the reel run through before the splice is made. However, cutting a straight end could lose a frame or more of the film picture and sound. Tricky, eh?

One more problem to think about, as far as choice is concerned, comes with knowing there will be more than one film. The first can be put on at the outset. How does one handle the others? With a manual projector, there is no problem. The first film is removed, another take-up reel put on, the second film threaded and cued up (quietly) and the show goes on.

When there is self-threader, however, the film's leader end must go through before the first frame is in position. If the machine is in the same room as the meeting, the manual unit gets the definite nod. It's easier to handle for one who is familiar with it. (Incidentally, it also helps to know how long the films are and how many so the proper take-up reels can be provided, both for size and quantity.)



WORAM AUDIO ASSOCIATES

Consultants in Studio Systems
Engineering, Design and Installation

—offering—

A COMPLETE CONSULTATION
SERVICE FOR STUDIO
PLANNING AND
CONSTRUCTION

FREE-LANCE RECORDING
SERVICE IN THE
NEW YORK AREA

516 764-8900
45 Lakeside Dr.
Rockville Centre, N.Y. 11570

“Eleven years ago Michael got leukemia. Last spring we got married.”

*Mrs. Ann Finamore,
Glen Ridge, N.J.*

“Michael's thirteenth birthday was supposed to be his last. And now we're celebrating our first anniversary. Because cancer research developed new treatments, Michael's alive. You should see how alive!

“There's a lot more research to be done and a lot more people to save. So give to the American Cancer Society. We want to wipe out cancer in your lifetime.”



American Cancer Society
This space contributed by the publisher

SLIDE PROJECTOR

When it comes to the slide projector, there are also some things to think about. If the slides will fit into one standard universal drum (assuming the projector to be the carousel type), the greatest safety is achieved with the grey drum. It will permit use of metal and plastic mounts as well as cardboard. The black carousel and the 140's are intended for thin plastic or cardboard respectively and will not handle the thicker mounts. The standard types of projectors will also be less of a problem, usually, even with cardboard, in the event one corner of the mount lifts off or curls slightly. The wider spacing permits a bit of leeway. The thinner slits do not, and a poorly mounted or bent cardboard will jam.

It is also better to use the autofocus models so that slides will focus automatically. When cardboard and glass mounts are mixed, there is sometimes (usually) a variance in the focus. If the presenter does not mind adjusting the focus manually from his remote control, fine; then it makes no difference in the choice of mount, or machine. It is much smoother, most times, however, for the machine to focus automatically. There is also a model and a control which gives the

"One year after I was operated on for cancer of the breast, David Sawyer fell in love with me."

Pat Sawyer, New York City

"When I was told I had cancer of the breast, I thought my life as a woman was over. A little more than a year later, David and I were married. And ten years later, I'm living proof cancer can be cured. Don't let vanity kill you. Learn breast self-examination and get regular checkups. And give to the American Cancer Society.

We want to wipe out cancer in your lifetime."

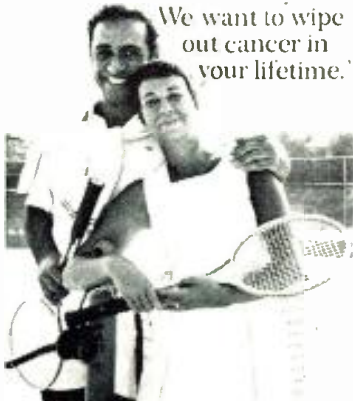

American Cancer Society

This space contributed by the publisher

presenter the option of manual override even with an autofocus. This could be the best, yet. (Incidentally, glass mounts, either in metal or plastic, keep the slides from curling as they are sometimes wont to do in cardboard, and will protect the film from finger handling.)

SCREENS

The location of the screen and the shape of the room make a big difference. If the room is narrow and long, a beaded screen is probably good. This type gives a very bright reflection, but in a narrow angle. The audience should normally sit no farther than 25 degrees to either side of the center line. Beyond this, the intensity falls off. (You will notice a similar effect, although at a different angle, with a rear screen, where the slide seems uniformly bright as you sit in the center, but falls off on the side opposite as you're moving either to left or right of center.)

With a lenticular or Ektalite screen, the angle can be spread to about 30 degrees at either side of center. Using matté material, however, allows for about 45 degrees on both sides of center, and thus offers the widest seating spread of all. This means that (with the front row about twice the width of the image away from the screen, and the last row about six times away) the front row should only be as wide as about two image widths for a beaded screen and the back row about six times as wide. For a matté screen, the front row can be as wide as about three times the width of the image, and the last row as wide as twelve images.

LENSES

The simplest though not very practical way to get the right lens for a projector is to take a series of them with you when you set up. For the slide projector, for example, you could take a 3 in., a 5 in., a zoom to cover 4 in. to 6 in., a 7 in., and a 9 in. size. There are also 8 in., 8½ in., and other lenses available. To be safe, you might get all of them just to have "in case." If you do the same with your film projector, your supply of lenses will take up more room than your equipment!

In most instances, the zoom and the 7 in. for the slide unit as well as the zoom and 2 in. for the film projector will suffice. If you will look at available charts you will find that for throw distances of 13 ft. to 94 ft., the 7 in. slide lens matches the 2 in. film lens, considering the requirements for screen width. Thus, if you project 2 x 2 in. slides from a distance that will fill a screen width, using a 7 in. lens,

the film will provide a similar size image with a 2 in. lens.

Where the size of the screen or the projection distance are such that a different size lens is required, trial and error on the site might be necessary until the projectors are positioned properly. However, it might help to determine beforehand what range of lenses, at least, you might need.

The formula says to multiply the projector aperture width in inches by the projection distance in feet, and then divide by the lens focal length in inches to arrive at the screen width in feet. To put this a different way, the lens in inches can be found by multiplying the aperture width (inches) by the throw distance (feet) and dividing by the screen width (feet). For the 16mm film projector, the aperture width is 0.38 in., and it's 1.3 in. for the slide projector. Using this calculation, you will be very close to the figure you want to determine the screen width you should have, the lens you'll need, or the throw distance you require for the equipment you will use. Remember that the longer the lens, the smaller the image will be from the same location, or the farther back you can go for the same size image. This reminds me of a poem I found a long time ago but can't remember where (apologies to the publication) written by Donald Canty:

*When you want to say a lot,
Put a short lens on the shot.
If you want to frame it tight,
Use the longest lens in sight.
If your actors move about,
Now in focus, now they're out.
To a shorter lens you yield
To increase your depth of field.
If the object seems too small,
Or you see far too much wall,
Then this lesson you must learn.
To a longer lens you turn.*

The poem is actually aimed at photographers, but parts hold true as well for projection.

Using these hints as guidelines, it might be a little easier to figure out what equipment to purchase, rent, or take out of stock for a presentation, what screen to choose for material and size, what lenses to take, and the extras you can find helpful to set up, run, and take down a show as if you really know what you're doing . . . professionally. ■

FREE CATALOG

HARD-TO-FIND PRECISION TOOLS

Lists more than 2800 items: pliers, tweezers, wire strippers, vacuum systems, relay tools, optical equipment, tool kits and cases. Also includes ten pages of useful "Tool Tips" to aid in tool selection.

JENSEN TOOLS AND ALLOYS
4117 N. 44th Street, Phoenix, Ariz. 85018



Circle 27 on Reader Service Card

● *An automated editorial or, "We'll fix it in the computerized mix."*

Those who proclaim that technology is slowly ruining the art of recording should have a field day with this issue of **db**. Each of the three automation systems described within these pages brings computer technology into the studio control room, where it may be used, or abused, depending on who's in charge.

Each system has its distinctive operational features. Necam gives us servo-driven faders, for instinctive update. Allison Research suggests a master control concept that eliminates the usual redundancy of console controls. Automated Processes uses its own time code, and stores instructions on a data cartridge.

Each system is totally incompatible with the others, although this may not be quite the disaster that it seems at first. So far, automation remains pretty much a mixdown tool, and usually mixdown work is confined to one *venue* anyway. An occasional feature might be useful during recording, such as instant reset of all equalizers, but this is not the sort of thing that needs to be carried from one studio to another.

VERSATILITY

Automation gives the engineer an incredibly versatile production tool. After a few mixes have been stored in memory they can be electronically edited into any conceivable sequence without lifting a razor blade. This feature can be used to advantage in classical music production work as well as in the more obvious multi-track applications.

In the former, each take may be assigned to memory, and when the artist or conductor decides he'd like

to hear several different edited versions of the performance, he may be obliged instantly. If the system is available during recording, this sort of instant editing may even be done during playbacks, thus saving a lot of educated guesswork about how it will all sound later on.

During any mixdown session, there is an obvious saving in two-track tape, since there is really no point in running the two-track recorder until the ideal mix has been worked out. And, if you are concerned about wearing out the multi-track master tape with repeated run-throughs, just make a work copy and use that until you've got your mix worked out. Then return to the master, press the button and go. If the two-track master sounds a bit bright, it could be that all those rough mixes gradually wore down the high end of the work copy, while the still-fresh master retains the original response. At least one manufacturer is studying this possibility, with an eye towards some sort of built-in automated correction factor.

Do these and all the other automated advantages mean that recordings will get better and better? The answer to that one is a definite yes and no. (And remember you read it here first!)

THE HUMAN INGREDIENT

Automation is just one more tool to be placed in the hands of the engineer or producer. But—science fiction notwithstanding—it doesn't have much brain power. That's one optional accessory that you have to supply yourself. If you don't understand the technology you're using, your production will surely suffer. But of course, that's as true of the simplest microphone as of the most sophisticated automation package.

By now, even pre-automation technology has progressed to the point where many people are getting left be-

hind. An interview in *Billboard Magazine* some time ago is a good—but depressing—example. An unidentified "industry spokesman" commented on recording equipment. "The real problem," he says, "is that this equipment is made by people who can't evaluate it from a musical viewpoint. And this is not only the people making consoles. This goes for microphone manufacturers and others you may not think of." Of recordings, he observes. "Noise-wise, the current ones are better. But from a musical reproduction, the older ones (20 years ago) win out."

Unfortunately, this sort of reverse logic is very prevalent in the industry. It goes like this:

Premise 1: Recordings of twenty years ago sound better than many of today's releases.

Premise 2: Technology has proliferated over the last twenty years.

Conclusion: Technology is ruining recording.

The more imaginative engineer will object to this sort of reasoning. He may point out that with the technology available today, it is possible to make recordings that are far better than anything produced even ten years ago. But he also knows that it is possible to demolish almost any performance by treating it as a sort of musical Heathkit, to be assembled after hours by a knob-crazed producer (or engineer). So, let's re-write that proposition:

Premise 1: Recordings of twenty years ago often sound superb when heard today.

Premise 2: Technology has proliferated over the last twenty years.

Conclusion: Today's recordings *could* sound even better than the older ones.

The key word is "could." The industry spokesman quoted above is distressed by what he hears, and blames technology. He forgets that *he* is still in charge though, and if he doesn't like what he hears, it's probably because he is mis-using the tools that are available to him. Give him a little automation, and he's really going to get upset!

Automation is not unlike atomic power; it can be used creatively or destructively, though perhaps the results are not quite so dramatic. Used creatively, by knowledgeable engineers and producers, there's no reason why it cannot become one of the most powerful tools in the advancement of the science—AND art—of recording. ■

PLAN FOR A CONCERT INSTEAD OF A BLOWOUT.

Quality. Backed by a five-year guarantee.

This cutaway view of a Gauss precision loudspeaker from Cetec Audio tells you a lot. Note the unique double spider (1) supporting the voice coil. It's designed to keep the voice coil wire (2) perfectly centered inside. Even under the most demanding applications. All the way up to 200 watts of continuous sine wave power. Because our unique design features a heat sink on the coil to dissipate the heat.

These are just two of the things that allow us to offer a five-year repair or replacement guarantee on every Gauss loudspeaker we build. But our guarantee wouldn't mean much to you if our sound reproduction wasn't superb.

We'll leave that judgement to your ear. Go see your Gauss loudspeaker dealer. Put Gauss loudspeakers up against anything you've ever heard. Then, plan a concert... instead of a blowout.

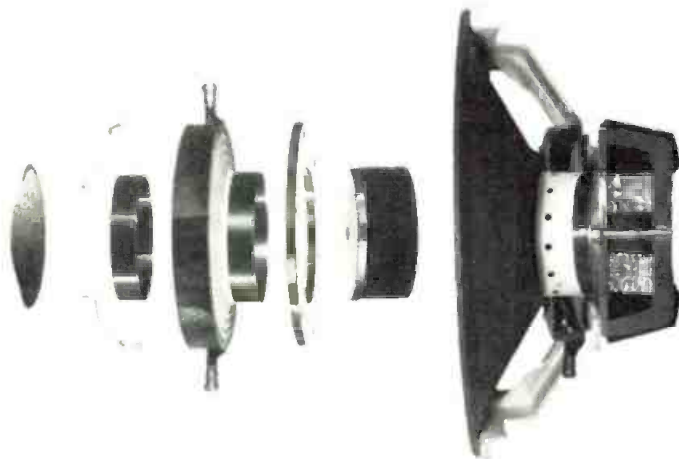

**Cetec
audio**

For the Educated Ear

gauss precision loudspeakers

CETEC AUDIO/A DIVISION OF CETEC CORPORATION
13035 Satcoy Street, N. Hollywood, California 91605
(213) 875-1900 TWX: 9104992669

CETEC AUDIO/ A DIVISION OF CETEC SYSTEMS LTD.
16 Uxbridge Rd., Ealing, London W52BP England
01-579-9145 Telex (851) 935847

Circle 37 on Reader Service Card

Check

our

Multi-TRACK RECORDers

The goal of every studio owner is to have the most reliable recording equipment available, knowing well that "down time" because of equipment failure costs him money. We at **STUDER** proudly feel that we not only have the most reliable recorders but that we also have a service philosophy that other companies envy. Let us tell you about it.

Write or call, Willi Studer America, Inc., 1819 Broadway, Nashville, TN. 37203. Phone 615-329-9576, Telex 55-4453. *In Canada*, Studer Revox Canada Ltd. Phone 416-423-2831, Telex 06-23310.

STUDER

a standard
of excellence.

db new products & services

STEREO EQUALIZER

● Eleven band per channel EQ-2 provides full equalization from 20 Hz to 20 kHz. Each band has a ± 15 dB boost or cut capability. The filters are of half octave constant bandwidth design, set nominally on octave centers; each filter has an associated control allowing ± 0.5 octave of the center frequency. The two channels can be cascaded to produce a full range half-octave equalizer. Controls adjust the bass or treble frequency response before detailed equalization. Transformerless balanced inputs and outputs provide either unity or switched 10 dB gain. Clip level indicators monitor four critical points in the circuitry to signal overloading. An automatic five-to-seven second muting at turn-on prevents the passing of system turn-on transients to the speakers.

Mfr: Crown International

Price: \$899.00.

Circle 48 on Reader Service Card



REAL TIME PITCH SHIFTER



● Special signal mixing and recirculation facilities useful for creation of unusual studio sound effects, as well as compressing and expanding speech in film and video editing are offered by Varispeech Model 27. Designed for use with variable speed sound reproducers, the units have external pitch control through remote resistance or voltage programming and interface for speed control where the connecting transport has that provision. Restoration of voice pitch at any speed setting is made possible by a micro-computer feature. Pitch and speed are controlled by a single calibrated speed factor dial. The manufacturer claims absence of splice noise and pop. Included are an led indicator, built-in headphone amplifier, and both XLR-3 and quarter-inch input and output connections.

Mfr: Lexicon, Inc.

Price: \$750.00.

Circle 49 on Reader Service Card

Perfect Timing

console mount clocks and timers

Reliable ESE clocks and timers are now available in compact (2" x 3.7" x 3.6") console mount enclosures with bright easy to read .33" red LED's. Provided with rear solder pins for connection to your own switching or the optional remote connector, 6' cable and pushbutton set. Other options include: BCD Output; Crystal Timebase; 220V-AC-50Hz; and Kit Form. In addition the ES-370 is available with Stop and/or Relay Contact Closure at Zero.

ES-172	12 Hour Clock	\$125.
ES-174	24 Hour Clock	\$125.
ES-370	100 Min. Up/Down Timer	\$180.
ES-570	60 Minute Timer	\$125.
ES-572	12 Hour Clock/Timer	\$150.
ES-574	24 Hour Clock/Timer	\$150.



Write, Wire or Call: (213) 674-3021

505 1/2 CENTINELA AVENUE • INGLEWOOD, CALIFORNIA 90302

Circle 25 on Reader Service Card

DIRECT BOX

● Impedance matching battery-powered IMP-1 Impedaverter gets more mileage out of economy equipment. It accepts input signals from lowest mic levels up to 1.5 volts and has an output impedance under 100 ohms, permitting it to drive up to 500 feet of line without high frequency loss or hum pickup. Permitting the recordist or performer to connect any microphone or instrument pickup to any mixer, recorder, or reinforcement system input, the device has dual inputs which allow bridging off other lines without loading the source. Dual outputs will drive a sound reinforcement system and a recorder or multiple recorders simultaneously. With IMP-1 it is possible to amplify a single mic or instrument pickup to line level without a mixer and to attenuate a high output mic or phase invert a signal. The portable unit is equipped with jacks.

Mfr: Russound

Price: \$59.95.

Circle 50 on Reader Service Card



BRINGING THE TECHNOLOGY WITHIN EVERYONE'S REACH



The technology is all around us. It applies to everything. It is the aim of **Sound Workshop** to utilize the technology to its limit and produce products with state of the art performance without state of the art prices. But how are we able to do this while other manufacturers have been unable to?

It's simple...experience and expertise.

Sound Workshop is made up of professional audio people who have designed some of the most sophisticated audio consoles in use throughout the world. We have also had the pleasure of recording most of today's top contemporary recording artists.

Experience and expertise. It shows:

Our **242A Stereo Reverberation System** has become the industry standard for low cost reverb.

Our **220 Doubler/Limiter** combines an electronic delay system with a state of the art audio peak limiter in one low cost package;

And our **1280 8-Track Recording Console** will revolutionize budget multi-track studio packages.

Bringing these products to you is our small but competent network of professional audio dealers that possess the experience and expertise necessary to meet your present and future audio needs. If you're interested in **Sound Workshop** products, or even someone else's gear, contact one of the dealers listed below. They make up **The Sound Workshop Creative Dealer Group**. Along with **Sound Workshop** they're bringing the technology within everyone's reach.

The Express Sound Co.
1833 Newport Blvd.
Costa Mesa, Ca. 92627
(714) 645-8501

Audio Concepts, Inc.
7138 Santa Monica Blvd.
Los Angeles, Ca. 90046
(213) 851-7172

Everything Audio
7037 Laurel Canyon Blvd.
North Hollywood, Ca. 91605
(213) 982-6200

Accurate Sound Co.
114 5th Ave
Redwood City, Ca. 94063
(415) 365-2843

Fred Locke Professional Audio
62 Woodlawn Road.
Berlin, Conn. 06037
(203) 828-1124

The Harris Co.
633 Shenandoah
Miami, Fla. 33145
(305) 854-2003

Milam Audio Corp.
1504 North 8th Street
Pekin, Ill. 61554
(309) 346-3161

K & L Sound Services
75 North Beacon Street
Watertown, Mass. 02172
(617) 787-4072

Systems & Technology In Music
2025 Factory St.
Kalamazoo, Mich. 49001
(616) 382-6300

AVC Systems, Inc.
321 University Ave. SE
Minneapolis, Minn. 55414
(612) 338-4341

Martin Audio/Video Corp.
320 West 46th Street
New York, New York 10036
(212) 541-5900

Audio By Zimet, Inc.
1040 Northern Blvd.
Roslyn, New York 11576
(516) 621-0138

Custom Audio Services
Rear 1356 East College Ave.
State College, Pa. 16801
(814) 237-1351

Nashville Studio Systems
16 Music Circle South
Nashville, Tenn. 37203
(615) 256-1650

Mission Sound Systems
1506 Dunlap
Mission, Texas 78572
(512) 585-6305

The Sound Workshop Creative Dealer Group.

Circle 41 on Reader Service Card

Sound Workshop
PROFESSIONAL AUDIO PRODUCTS

1038 Northern Blvd., Roslyn, New York 11576
(516) 621-6710

UNUSUAL OPPORTUNITIES

Our client, one of the country's largest designers and installers of:

CLOSED CIRCUIT TV SYSTEMS, AUDIO, SURVEILLANCE AND TELEPHONE INTERCONNECT SYSTEMS

requires the services of top flight, creative salesmen who are looking for a growth opportunity in each of the above areas. The candidate should be a person who welcomes the opportunity to show his ability and has the desire to create a sales record to support the responsibilities. He should be familiar with and able to sell to professional end users, systems utilizing some of the equipment listed below:

In TV		In Audio	In Telephone
Shibaden	I.S.I.	Dukane	Ericson
Hitachi	J.V.C.	Altec	Rohm
Panasonic	Dynair	Executone	Tele-Resources
Sony	ADC	Bozak	ITT
Conrac	CVS	JBL	Nippon
Ball Brothers	Thompson CFS	Tascam	OKI
Lenco	Comtec	Crown	Hitachi
Ampex		Shure	Automatic Electric
			Stromberg

In addition, our client seeks experienced technicians for service and installation of telecommunication systems.

Prefer people from the area of Ohio, Indiana, Ky., Michigan and Western Pennsylvania. Salary is open and our employees know of this ad.

Reply in confidence to:

Dept. 112

dB Magazine

1120 Old Country Rd.

Plainview, N.Y. 11803

YOUR "FISH SCALE" WAS DESIGNED TO WEIGH FISH!

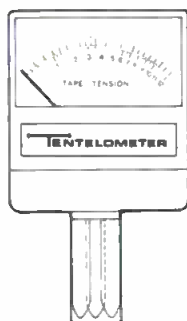
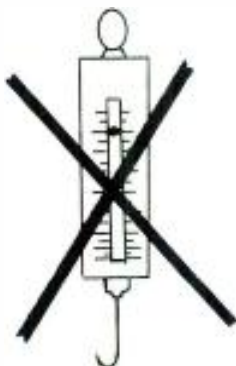

The Tentel tape tension gage is designed to diagnose problems in your magnetic tape equipment. Throw away your fish scales (or put them in your tackle box where they belong). The TENTELOMETER will measure tape tension while your transport is in operation, so you can "see" how your transport is handling your tape . . . smooth, proper tension for quality recording? or oscillating high or low tensions causing pitch problems, wow and flutter?

"See" what your heads "See" and HEAR the difference.

Tentel
50 Curtner Avenue

(408) 377-6588
Campbell CA 95008

Circle 16 on Reader Service Card

DISCO LOUDSPEAKER



● A 12 in. bass driver for effective low end response is featured on HD 12 loudspeaker. A high-temperature epoxy bonded voice coil is provided for increased power handling. The unit handles 100 watts continuous program and 400 watts peak power, with a frequency response of 50 Hz to 20 kHz \pm 3 dB. The 90 degree horizontal, 30 degree vertical dispersion pattern is controlled by an exponential horn (600 cycle flare rate), effectively loading the driver to 1200 Hz. In addition to its internal 12 dB per octave passive crossover, the unit is equipped with screw terminals for direct bi-amp access to the low and high frequency sections.

Mfr: ESS, Inc.

Circle 54 on Reader Service Card

PARAMETRIC EQUALIZER



● Stereo four-band parametric equalizer SC-66 may be set sharply enough to equalize an individual musical note. Claimed distortion is less than 0.05 per cent and noise -87 dBV. Four overlapping bands cover the entire audible range (16 Hz to 23 kHz). The power supply is self-contained. Applications include feedback control, acoustical correction, improvement of mic and speaker response, and generation of special effects.

Mfr: Ashly Audio, Inc.

Price: \$599.00.

Circle 55 on Reader Service Card

PORTABLE MIXING SYSTEMS

● Four new mixing systems have recently been introduced by this manufacturer. The M 82 line includes M 82-1 Musicians' Mixer system, M 82-II VCA Stereo Mixing system, B 82-B Broadcast system, and M 82-C Consultants' system. Each system has eight master input channels with optional 4-input sub master additions, providing a maximum channel complement of 24. The units feature a foldback system and separate monitors. The lightweight mixers, constructed of 14 gauge steel, weigh less than 26 pounds,

Mfr: EDCOR

Circle 51 on Reader Service Card



MULTIBAND AUDIO PROCESSOR



● Eight independent bands of compression to increase carrier modulation to a figure approaching theoretical maximum are present in Model 230 multiband audio processor, designed for a.m. and f.m. radio broadcast use. Each of the eight bands has individual threshold and compression adjustments, permitting response shaping to complement the programming format. A final peak limiter contains program peaks within absolute prescribed limits. Other features include gated expansion, program-controlled phase inversion, and separate frequency-selective limiter for f.m., with both 25- and 75-microsecond characteristics.

Mfr: Inovonics, Inc.

Circle 53 on Reader Service Card

REVERBERATION CHAMBERS

● Extended bass response is notable in the MasterRoom reverberation chambers. Normally rolled off at 6 dB per octave below 200 Hz, extended bass response units carry the flat response to 50 Hz and are less than 8 dB down at 20 Hz. Units with this characteristic are the same price as the rest of the manufacturer's line. Kits may be purchased to convert existing units to the extended bass capacity.

Mfr: MICMIX Audio Products, Inc.

Circle 52 on Reader Service Card

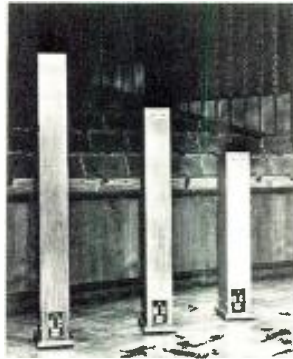

The Sensible Alternative MX-7308

Sensibly priced at \$8150 including console Compatible one-inch eight track format Motion sense logic to prevent tape damage Reel tension servo to improve start time Professional 600 ohm +4 or +8dBm outputs with XLR connectors Optional remote synchronous-reproduce on all channels 15/30 ips now available from stock (7½/15 ips on special order).

OTARI

The only company with both one-inch and one-half inch eight track recorders

Otari Corporation

981 Industrial Road, San Carlos, Calif. 94070

(415) 593-1648 TWX: 910-376-4890

In Canada: Noresco Mfg., Toronto (416) 249-7316

MANUFACTURED BY OTARI ELECTRIC CO. TOKYO, JAPAN

Circle 20 on Reader Service Card

SENNHEISER. YOUR WAY.



SENNHEISER CONDENSER
PERFORMANCE HERE

48V CENTRAL POWER
SUPPLY HERE

Now, you don't have to give up the ultra-low-noise, wide-range response, superior linearity, precise directionality and easy-to-position compactness of Sennheiser RF condenser microphones... to get the convenience and compatibility of 48V central studio supplies.

Due to popular demand, our MKH condenser microphone series—cardioid, ultra-cardioid, shotgun... even our lavalier—is now available in "P" versions, directly compatible with all standard 48V sources. As an alternative to our present A-B version, which can be powered from a built-in battery supply, or directly from low-voltage devices, such as Nagra tape recorders, mixers and other field equipment.

For more information, please write or call us... or better yet, contact your Sennheiser dealer for a demonstration.

Sennheiser Electronic Corp.,
10 West 37th Street, New York,
N.Y. 10018 (212) 239-0190

Manufacturing Plant: Bissendorf,
Hannover, West Germany

Circle 26 on Reader Service Card

HIGH POWER AMPLIFIER

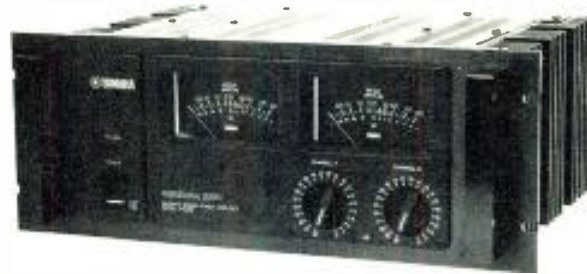

- High power handling recommends P-2200 amplifier for disco use, while the precision of the peak-reading meters, which display five decades (50 dB) of output level, suits the unit for studio monitoring. Less than 0.5 per cent thd is claimed at full rated power. The peak meters have illuminated faces marked with dB and watts-into-8-ohms scales (the unit packs 4-ohms sustained output at 350 watts). Input attenuators are marked in 22 calibrated dB steps, detented for extra accuracy. Other features include input connectors for both channels, including one male and one female XLR connector, a parallel phone jack, a polarity switch allowing either pin 2 or pin 3 to be selected. Outputs use 5-way binding posts which give the choice of direct-wired connections or high-current banana plugs.

Mfr: Yamaha International Corp.
Circle 56 on Reader Service Card

TAPE-PLAYBACK EQUALIZER

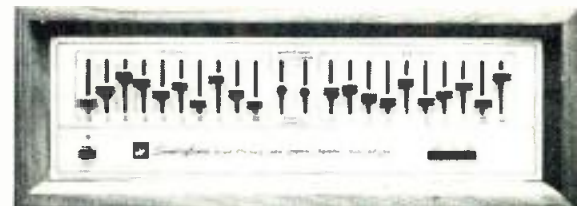

- Featuring octave-by-octave graphic equalization, RP2204 equalizer is designed for connection to the tape monitor circuit of any stereo receiver or preamplifier. It includes its own tape monitor inputs and outputs with front panel pushbutton selection, which also provides tape record equalization switching and automatic "equalizer-on" for environmental equalization (an environmental test record is included). The unit has two completely separate ten-octave equalization panels, with plus or minus 12 dB boost and cut provided for each channel, enabling exact balancing of input to output levels within an 18 dB range.

Mfr: Soundcraftsmen
Price: \$329.50.

Circle 57 on Reader Service Card

A MASTER OF THE ART TALKS ABOUT MASTER-ROOM™

"We have used Master-Room reverberation with Stevie Wonder, Neil Diamond, Joe Walsh, Petula Clark, Rufus, Fleetwood Mac, Tower of Power, Billy Preston, Sergio Mendez, Isley Brothers, Ramsey Lewis and a number of others. In fact we have used our Master-Room chambers on virtually every record we've done here.

"What I like about Master-Room sound primarily is the relatively clean first order echo. It's a real smooth system.

"We like it especially on electronic instruments, and the Master-Room can even take drums and sound good. It's much better than any other comparable type reverb and costs much less.



"Here at Kendun Recorders we have unlimited funds for equipment and we can afford the best. So, along with our live chambers, there are two or three Master-Room units in each of my rooms.

"I would feel incomplete without my Master-Room chambers."

Kent Duncan
President
Kendun Recorders
Burbank, California

Master-Room reverberation chambers alone won't make you a Master of the Art, but they will provide you with the very finest in Natural Sound Ambience.

Models available to suit every need.
See your dealer or write direct.

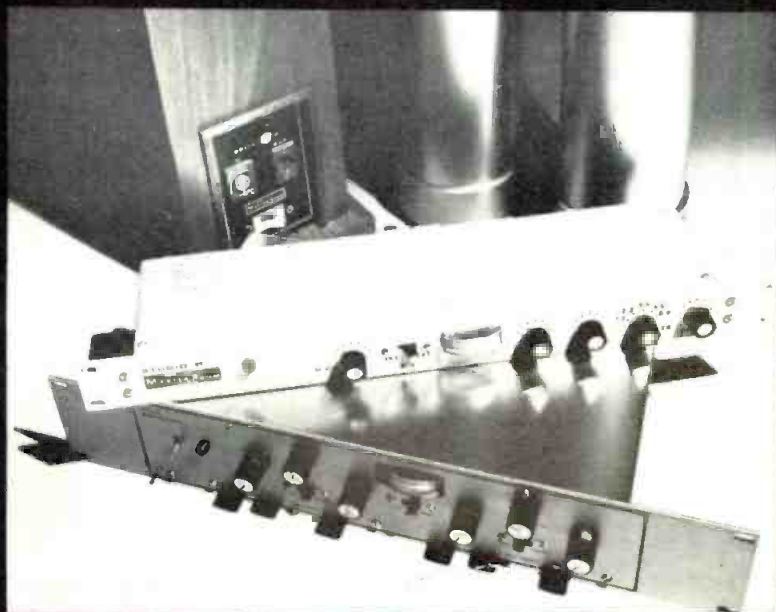

Circle 42 on Reader Service Card

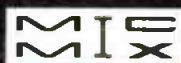

MICMIX AUDIO PRODUCTS, INC.

9990 MONROE DRIVE, SUITE 222 • DALLAS, TEXAS 75220

(214) 352-3811

www.americanradiohistory.com

A sine wave time code minimizes crosstalk and enables locational information to be read at high speed, even with the tape lifted off the head.

JOHN WORAM

A Look at Automix



AS MANY READERS may know by now, when a 16-track studio becomes automated, it simultaneously becomes either a 14- or a 15-track studio, depending on the automation system used. Some require two tracks for the automation instruc-

John Woram, in addition to being a regular **db** columnist, is an audio consultant, an instructor in the New York Institute of Technology's graduate program, and, most prestigiously, author of the newly published **RECORDING STUDIO HANDBOOK**.

tions, while others put a SMPTE time code on one track, with a synchronized floppy disc used for data storage.

In developing its current "Automix" system, Automated Processes has chosen a variation on the latter technique, using the company's own time code instead of SMPTE's. Automated's Carl DeWilde explains that the SMPTE code—essentially a square wave—has a tendency towards cross-talk, and may often be readily heard on adjacent audio tracks. With the tape recorder in fast forward or rewind, the code's playback frequency is so high that a special wide band amplifier is required, and the tape lift mechanism must be defeated in order to read it, with this in turn causing additional head wear.

The Automated Processes time code is modulated on a 3 kHz carrier, and looks like a sine wave, with no more cross-talk than any audio signal. In addition, there is a 30 Hz carrier which enables location information to be read at high speed, even with the tape lifted off the head.

FIRST MIXDOWN

Automated's data storage medium may be easier to use than to explain, but here goes anyway. During a first mixdown, the console is scanned 37.5 times per second, and the analog VCA levels are converted to digital information and stored in one of three "cache memories" within the programmer. This stored information—in increments corresponding to about 1.7 seconds of real time—is then transferred to the data storage medium (more on this in a minute) in a fraction of a second, while the programmer is storing the next increment of information, which will then be transferred in the same manner.

THE 3M DC 300A DATA CARTRIDGE

Automated Processes' data storage medium is the 3M DC 300A Data Cartridge, chosen because of its physical durability and a storage capacity that is about ten times greater than the floppy disc. DeWilde points out that the cartridge does not run continuously but rather in short spurts, during which the data is either written (recorded) on, or read (played back) from, the cartridge. Since these brief spurts take place in a fraction of a second, and transfer almost two seconds' worth of instructions, there is plenty of time for the data tape to shuttle ahead or backwards, while the programmer is using up the previously stored 1.7 seconds' worth of information.

On the odd chance that this explanation is not crystal clear, consider the following typical situation. At $t=0$, a mixdown is begun. For the first 1.7 seconds, the data cartridge does not move; however the programmer is storing instructions in one of its three cache memories. At $t=1.7$ seconds this information is entered on the data tape. The transfer takes a fraction of a second. Meanwhile, the next 1.7 seconds' worth of instructions ($t=1.7$ —3.4 seconds) is being stored in another memory. At $t=3.4$ seconds, this information will be transferred to the data tape, and so on.

During playback, the data cartridge transfers the first 1.7 seconds of stored instructions back into the programmer, and from there it is converted back to analog and routed to the VCAs in the console, while the time code—which has been stored and retrieved along with the mixing instructions—keeps everything in sync.

To "update" the mix, new instructions are entered on the data cartridge. Within each "data block" of 1.7 seconds, there is room for ten different sets of mixing instructions, although during routine operation only two sets will be stored. These are known as "current" and "previous."

To get through this part of the system, let's look at another typical situation. The session begins with a series of rough mixes, which we'll call A, B, C and so forth. The first few mixes aren't worth hearing, and so we continue mixing without wasting time listening to playbacks. However, at the completion of mix F, we decide to have a listen by simply playing back the multi-track tape, the "current" mix (F) will be heard. We may also hear the previous mix (E) by depressing the "previous" button. However, all earlier mixes have been lost. (Remember that up to now there has been no reason to do any actual recording onto a two-track tape)

If we hear nothing worth saving, and go back to mixing, then as mix G is being done, F becomes "previous" and E is lost.

Sooner or later, there will be a mix worth saving. Let's say that R shows promise, but that S is a disaster. Before going on to T, we depress the following sequence of buttons: "previous," "store," "1." Mix R is now stored in Memory 1. Now, as mix T begins, R is replaced by S in the "previous" slot, but is retained in Memory 1 for future recall. Seven other mixes may be stored in Memories 2 through 8.

As the evening wears on, and the memories fill up, we may discover that the ideal mix seems to consist of the beginning of Memory 5, the middle of 3, and the end of 8. No problem. We simply play back the tape, depressing Memory buttons 5, 3 and 8 at the appropriate moments. If the changes are particularly tight, the tape may be stopped and rocked into position—as in editing—but in most cases this type of compositing may be done while the tape is playing.

This composite mix is now the current one, and as we listen we discover we can use a bit more drum sound here and there. Again, no problem. We can update the drums as we go along. The composite 5, 3, 8 becomes "previous" and the corrected composite becomes "current." As you may suspect by now, we can store the composite 5, 3, 8 and/or the drum-corrected version in one or two unused memories and go on mixing and re-mixing, long into the night. Or we can unload the cartridge and come back again tomorrow to pick up the pieces. We don't even have to remember the equalizer settings, since the data cartridge attends to that for us.

THE AUTOMATED EQUALIZER

Unlike the Allison master equalizer concept, the Automated Processes board has a standard-looking three-knob/three-switch equalizer in each module. During mixdown, the settings may be adjusted in the usual manner. However, if changes are made, then during playback there will be no similarity between the physical settings of the knobs and the actual equalization being heard. The knobs remain just as we left them, while the actual equalization settings correspond to the changes we made during the mix.

It is conceivable that we might be listening to a segment where, we recall, the equalization was say, -6 dB @ 7.5 kHz, although the equalizer knob/switch combination now shows perhaps $+3$ dB @ 10 kHz, since that's where it wound up by the end of the mixdown. If we wish to update the equalization, the knobs must be returned to the early setting first, or there will be a very sudden change as the equalizer leaps toward $+3$ dB @ 10 kHz. On the other hand, if we don't happen to recall the former setting, the equalizer may be "nulled" by depressing a pushbutton on the appropriate input module. This addresses a 6-led null indicator to the equalizer, and the leds indicate when each of the six equalizer controls has been matched in position to the actual equalization present at the moment. Once this has been done, a smooth update transition may be made.

The procedure is probably more of a chore in theory than in practice, since radical changes of equalization are usually not required within most routine mixes. If there is to be a significant change of settings, it probably happens during a pause or break of some sort. Therefore, updates probably do not require the nulling procedure anyway.

WHAT ABOUT RECORDING?

In most cases, the Automix console is not intended for use on involved multi-track recording sessions. Typically, the console will be equipped for overdubbing purposes, but will not have a microphone level input on every channel. In its standard configuration, the Automix board may have up to 32 inputs and 4 outputs. ■

Allison Research computerizes equalizers and faders, keeping the fancy hardware to a minimum.

JOHN WORAM

Paul Buff and the “Memory Plus”

AUTOMATION? The word usually conjures up visions of super consoles with faders sliding up and down, guided by unseen hands (see John Borwick's story in this issue). Above the console, a CRT terminal keeps the engineer in touch with what's happening, and nearby there is a keyboard for giving instructions to the computer, which may be down the hall somewhere. (Also down the hall somewhere, the maintenance man has locked himself in the bathroom, cowering in terror at the thought of an equipment breakdown.)

Allison Research was one of the early pioneers in the automation game, and their second generation hardware offers an interesting approach to the automated console. In explaining the system, Allison's Paul Buff points out that during even the most complicated non-automated sessions, relatively few functions are being changed at any given instant—a point that is not being overlooked by some of the competition's second generations either. The truth is that the overwhelming majority of the console's hundreds of buttons, knobs, switches and faders are—most of the time—lying untouched.

But with all of these controls available, it takes time for a computer system to scan a complex multi-function console, searching for chores to do, like gain riding, equalization changing, panning, echo-sending, and what-have-you. If the engineer is making just one or two changes out of a possible thousand or more, the computer is obviously wasting a lot of time, scanning all those static functions.

So, Allison Research's new Memory Plus does not scan the entire system, but rather responds only to function

changes. Therefore, if the five drum tracks are just fine, the computer ignores them and concentrates where assistance is needed.

Unlike the earlier Memory's Little Helper system, which used a quinary (i.e. five possible states) system, Memory Plus is binary. Therefore, all information is represented by those familiar 1's and 0's, eliminating much of the ambiguity that can creep into more complex encoding systems. Now, the data takes the form of digital “words”—a series of rounded-off square waves, with a one represented by a 100 microsecond duration pulse, and a zero by 50 microseconds.

The first twelve pulses, or *bits* gives the “address” of some console function. Since each of the twelve bits can be either a 1 or a 0, we have the possibility of 2^{12} different addresses, or 4,096 separate functions. For example, the address of fader 17 could be 00000011011, leaving 4,095 addresses available for everything else.

We wondered if that wasn't a bit extravagant, since even an unlikely 48 in/48 out console with twenty separate controls in each of its input and output channels would require a mere $20(48 + 48) = 1,920$ addresses. However, the twelve-bit capability means that the console and system can easily accommodate a variety of different types of signal processing devices with a minimum of confusion. For example, a Brand X equalizer in channel 7 could have a certain address of its own. If a Brand Y equalizer was inserted in channel 7, it would have a different address. Therefore, instructions intended for one device would not wind up confusing another one.

The twelve bit address is followed by sixteen bits of

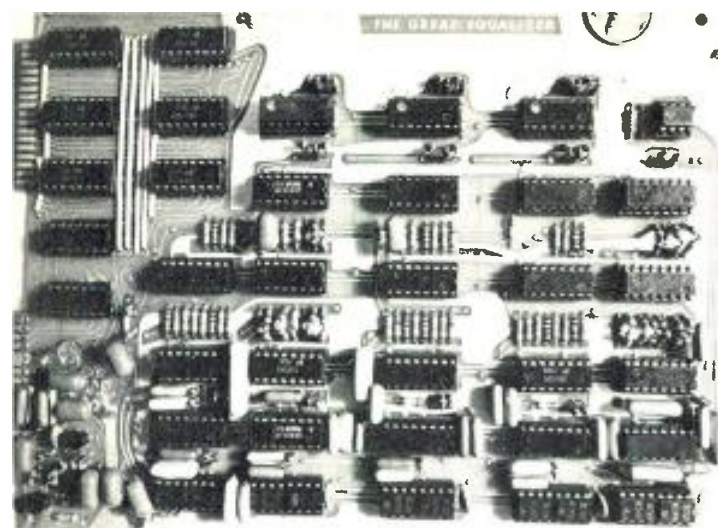

Allison's "The Great Equalizer."

data. For a fader address, the data consists of:

- 8 bits—level
- 1 bit —muting
- 1 bit —solo
- 2 bits—input assign (will assign 1 of 4 possible inputs)
- 4 bits—group assign (will assign to 1 of 16 group masters)

For level control, eight bits = $2^8 = 256$. Therefore, the fader can be placed at any of 256 different levels. The Allison system covers the first 48 dB in 0.25 dB increments, and then goes to 1 dB increments, for a total dynamic range of 112 dB.

THE ALLISON EQUIPPED-CONSOLE

For the moment, Allison Research is building equalizers and faders only, with the total system to be put together by others. This should suggest all sorts of intriguing possibilities for the confirmed do-it-yourselfer.

For those who equate versatility with size, an Allison-equipped console may appear deceptively simple. To understand why, Mr. Buff has done away with most of the redundancy of knobs and things that clutter up the usual super-board. For example, consider an equalizer with the following functions:

- High frequency cut-off—8 selectable frequencies, 18 dB/octave;
- Three bands of equalization—8 selectable frequencies in each band ± 15 dB peaking or shelving;
- Low frequency cut-off—8 selectable frequencies, 18 dB/octave;
- Equalization in/out switch;
- Phase reversal switch.

In a conventional format, such an equalizer would certainly contribute its share of confusion to the general clutter. But Buff feels that the engineer spends comparatively little time looking at the equalizer, and when he does, the packing density makes it hard to "read out" anyway.

MASTER PANEL

As you may suspect by now, the Allison equalizer doesn't have a knob anywhere, as you can see in the picture. Instead, there will be a conveniently located master panel containing a series of momentary contact pushbuttons and a visual display of one channel's-worth of equalization functions. To set the equalizer in, say, input 3, just press a single pushbutton above fader 3. The master panel shows the equalization now in the channel 3 equalizer. Punch in some new e.q. settings on the panel and these instructions are instantly entered in the equalizer. To change the e.q. in another channel, just depress the push-button above the appropriate fader and repeat the process.



Allison's "The Fabulous Fader."

As an added bonus, the e.q. setting may be displayed on a cathode ray oscilloscope as a frequency response curve which changes as you vary the equalization setting. And when the session is over, a master clear button will remove all e.q. settings, across the board. Or if you like, you can retain the e.q. settings in memory and recall them later. More on this after we discuss the faders.

FADERS

The faders are different too. Perhaps our picture doesn't help much, but the fader is an optical counting device, using an endless belt. To operate, just slide your finger up and down the belt. The belt moves, and its opaque bars interrupt an optical path between an infra-red emitter and a pair of photo-detectors, and the audio level changes in 0.25 dB increments.

To let you know where you're at, a series of 32 leds shines through the belt, indicating the "position" of the fader, just as the old fader knob used to do. But unlike the knob, the belt can be touched—and therefore moved—from any point along its exposed path.

Now then, once you've established a basic starting point for each input level and equalization setting, this collective data may be stored on a conventional cassette tape by depressing the *load preset* button on the master panel. A series of presets can be stored, and then returned sequentially by depressing the *activate preset* button. This could make life on the road a lot easier. Each tune could have its own basic preset of balance and equalization stored, and the board could be set and re-set instantly with a minimum of hassle.

For the studio planning a gradual shift towards automation, Memory Plus may begin as a direct replacement of the existing faders, plus an external central controller. This will give the user automated level, mute, solo, group and input assignment capability. As with the equalization master panel—which can be added later on—there is a two way link between the faders and the central controller. For example, to "read" the faders that are assigned to group 15, just depress the group master 15 button at central control. An led at the top of each fader assigned to group 15 will light up. To assign a fader to any group, just depress the push-button above it, while holding down the appropriate group master button. Other buttons allow clearing individual functions or the entire console.

Memory Plus is not married to any particular data storage medium. So, depending on your needs, those ones and zeros can be stored on a floppy disc, an auxiliary tape deck, or on two tracks of your master tape.

As a final incentive, Buff feels that a completely equipped console may actually be lower in price than a conventional board, since the cost of the automation is more than offset by elimination of countless controls. ■

The console's automation is cannily designed to give an engineer octopus hands and a stupendous memory.

JOHN BORWICK

Meet Neve's Necam

NECAM stands for Neve Computer-Assisted Mixing, representing a wholly novel approach to automation in the recording studio. It's built by Rupert Neve and Company, who, operating from a tucked-away model factory in the English countryside, have built up a formidable reputation for superbly designed and constructed mixing consoles which they have put into top studios in all corners of the world—80 per cent of their production is exported.

When Neve throws its particular hat into the automation ring, we can be sure it is with an entry to be reckoned with. Neve design engineers not only know how to make very good mixing desks, but they spend countless hours in working studios with the wizards of the knobs and tapes, becoming aware of the problems that crop up there daily.

The first thing that hits you between the eyes when you see NECAM in action or get the feet of it for yourself is that the fader slide controls actually move up and down continuously during playback to the positions they occupied at the time of the original mixdown. This is similar to what one sees in the control cabin of a modern aircraft when the auto-pilot is in use: all the knobs and levers continuously move to their operative settings as if manipulated by invisible hands. The reasons for this are the same as those that dictate the NECAM design—(a) to let the knobs themselves act as indicators and (b) to enable the engineer to take manual control instantaneously.

According to Geoffrey Watts, Neve's engineering manager, when designing NECAM they took five factors as their criteria, aiming to eliminate dull and repetitive tasks on the console, speed up mixing operations, and offer the engineer positive help towards enhancing his artistic results. The main idea was to give him more hands, effectively, and a greatly improved memory so that he could concentrate on optimizing the finished product.

Here are the five Neve desiderata: integrated tape control, instinctive update, unlimited recall, merge capability, and time independence.

INTEGRATED TAPE CONTROL

The main situation for which NECAM was designed is where a multi-track master tape has been compiled—perhaps after many hours of overdubbing—and now has to be mixed down to a two-track stereo (or possibly four-track quadripionic) master for processing. A typical remix flow chart is shown in FIGURE 1. The multi-track master must be run and rewound several times—first to allow the engineer to set such treatments as e.q. (frequency correction),

pan, and reverb; secondly, to try various level balances before the optimum mixdown is recorded and finally approved. Clearly this involves a great deal of rewinding to a cue, which may or not be the start of the track, putting a considerable strain on the engineer's ability to remember what he did, when, and where.

The NECAM solution is to harness a small computer to the sound mixing console (it is the Model LSI 2/10 produced by Computer Automation) and program it to fulfill all the engineer's locate—store—recall—control—merge functions at the touch of a button. A key feature is the laying of a data track on the multi-track tape itself (see FIGURE 2). This robs the studio engineer of one of his signal tracks, so that he must make do with 15 music tracks instead of 16, or 23 instead of 24, but it is actually simpler than some other proposed systems which either require two data tracks or the complication of a special synchronized auxiliary data recorder.

The data track is a simple audio pulse one comprising a time code to which the computer relates both memory and command functions. Any number of sequential mix-down runs can be stored in a separate memory bank, consisting of a "floppy disc" store, to be recalled later. The time

Figure 1. Remix Flow Chart.

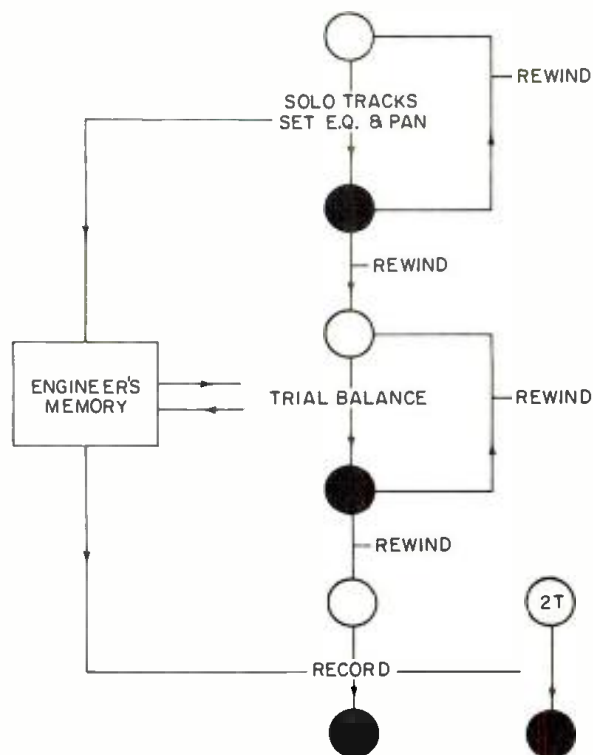

John Borwick is Audio Editor of the British publication "The Gramophone" and is Senior Lecturer, Recording Techniques, in the Department of Music at the University of Surrey, England.

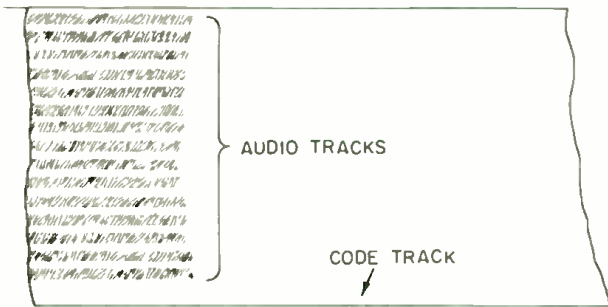

Figure 2. Typical Code: 07 38 46 09

code employed is the standard SMPTE edit one, with eight digits representing hours, minutes, seconds and "frames" so that interface with vtr and film systems is simple. Because it is tolerant of drop-outs, splices, and even leaders in the tape it can be assigned to an edge track. The computer actually scans five frames of the data track simultaneously to check their validity.

All the usual transport remotes are provided—wind, rewind (with the tape away from the heads), play and pause. The term *pause* is used rather than *stop* because, though the transport is halted, the take is not terminated until either the *keep* or *clear* button is pressed. All functions are programmed from a display-control unit which is shown in the photograph (FIGURE 3) and at the center of the schematic diagram (FIGURE 4). A most useful feature is that the mix can be tackled in segments of only a few bars at a time if necessary. These are identified by labels, which are simply numbers which the computer associates with the time code, and define the start and finish of any segment. Up to 999 separate points may be so defined—which should be enough for even the most complex album side or wayward producer.

The display-control unit, besides indicating the time code and mode in use, has a number of polite messages for the user such as *tape has reached "TO" Label* (end of a segment), *Please touch required faders* (when sub-grouping is desired), *Label X has not been defined* (when the operator has asked for a "wrong number") and *Storing labels—please wait* (the system has acquired more than 30 labels and is therefore quietly transferring them to the Data Disc).

INSTINCTIVE UPDATE

It goes without saying that any automated system must give the operator the ability to listen to a previous mix and then update it by altering the balance setting of his faders. In other approaches to this problem, the faders have been

Figure 3. The display control unit.

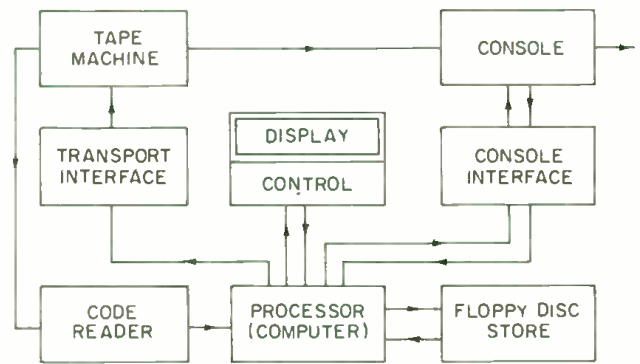

Figure 4. Key parts of the system.

converted into d.c. potentiometers whose voltage outputs have in turn controlled the gain of vca's (voltage controlled amplifiers). An analog-to-digital converter (adc) has been needed to translate the instantaneous voltage at the slider of each fader into digital terms, while the resultant information has been stored in real time on one track of the multi-track tape. In this way, every move of the operator during a trial mix can be stored alongside the music tracks as he operates.

On replay, a digital-to-analog converter (dac) can retrieve the control voltages and drive the vca's so as to repeat the mix exactly as the operator did it before, without his needing to touch a control. But when the engineer wants to perfect the mix by updating the stored information, there are problems. Clearly he cannot reconnect a given fader unless it is first set to its instantaneously correct position—otherwise a step in level would be introduced. Some systems, therefore, have a small meter by each fader, reading the dac output and perhaps supplemented by pairs of lamps.

Others make the vca level dependent on the sum of the dac and fader outputs, so that the operator has all his faders set to zero during the first replay and makes amendments by raising them. But there are drawbacks to this arrangement, in that he may unwittingly exceed the permitted input swing to the vca and of course he has lost

Figure 5. Automated control of the faders.



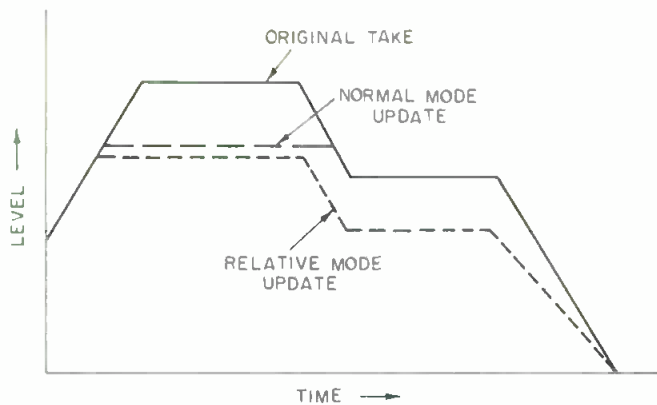

Figure 6. Any correction made manually will apply proportionately to all remembered movements thereafter.

the unique indicating feature whereby the knob positions give a graphical display of the levels within the mix.

Worse still, both the above systems take up a second track on the tape for the amended mix, and they can only remember one previous mix at a time.

The NECAM system can store literally dozens of mixes and yet it only steals one track of the multi-track master. The servo-motor driven faders give continuous indication of the moment-by-moment level on each channel or group of channels, as already mentioned. The faders are of the normal plastic track type and control audio levels in the usual way, thus avoiding the limitations of vca circuits. The fader knobs are touch sensitive (that is they incorporate a proximity switch which tells the computer to record the changed information) and the operator simply follows his instinct during a re-run. He can change from the *read* to the *write* mode by resting a finger on the faders he wishes to rebalance on the new take.

FIGURE 5 is a close-up photograph of the NECAM faders. A three-position switch can be seen above each one. This provides versatility in update in three distinct modes:

(a) *Manual mode* disables the fader servo, to cancel any remembered activity and allow the operator to choose settings at will—which will, of course, be stored this time round.

(b) *Normal mode* permits direct control by the computer, so that when the operator releases contact with the fader knob after making an adjustment, the fader remains stationary until the next stored moment arrives, when it reverts to that stored position. This is shown in the level/time diagram of FIGURE 6.

(c) *Relative mode* decrees that any correction made manually will apply proportionately to all remembered

Figure 7. A view of the system in action.



movements thereafter (see FIGURE 6 again). This allows one track to be lifted or decreased for the rest of the whole mix without the need to “ride the fader.”

UNLIMITED RECALL

As has been mentioned, the system can commit to memory store dozens of trial mixes and recall any of these at a moment's notice. When the final mix data, plus any others required, are stored in the floppy disc, which resembles a thin 45 rpm record in its sleeve, the disc fits neatly in the tape box along with the tape.

MERGE CAPABILITY

The advantages of the NECAM method of relating all functions to the time code track really come into their own in the *merge* situations. Without the need even to move the tape, the computer can be requested to build up a final take—just by handling data—which can comprise short segments of the two-track copy made during different mix attempts (this corresponds to electronic butt splicing and, since each segment will normally follow the ending of the prior take, no discontinuities in the music signal will exist), or even assorted subdivisions of individual tracks. For each merge trick, the operator gives simple routine instructions to the keyboard and the computer does the rest.

TIME INDEPENDENCE

Mixdown sessions can be long and exhausting, with vital artistic and technical decisions often made in the small hours of the morning. A computer assisted system like NECAM—which has a perfect memory, will recycle short or long takes, butt or overlap them, even work at half speed and store as many trial mixes as necessary—will encourage studio personnel to break off and resume work when they are fresh. Since the floppy disc store can be packed with the multi-track master, the whole history of the remix sessions can be preserved.

Notice too that there is an advantage not so far mentioned. With the appropriate tape machine interface at the disc-cutting channel, it would be possible to cut straight to disc from the multi-track tape without the need ever to have made a stereo or quadraphonic master tape—eliminating a generation of quality-degrading tape copying.

TO SUM UP

Neve's NECAM has clearly got a lot going for it and studio managers will be seeking more detailed information and demonstrations. As I write, you need to visit England to see all the hardware and software in action. But I am told that Geoffrey Watts is considering making a video recording of his demonstration and it might be possible to view this in the USA or anywhere else on request. A view of the NECAM system in action is shown in FIGURE 7.

Some may argue that this return to electro-mechanical devices such as servo-motors is a retrograde step, since these have a past history of poor reliability. However, Neve argues that today's devices have high reliability; no clutch system is used, so manual operation of the fader is against the load of the motor and just gives a smooth damped feel.

It might also be asked why the computer-assisted operation in NECAM has been applied only to channel and group faders (plus perhaps such obvious extras as master reverb send and return). Neve says that extending this to cover e.g., stereo width, panning, etc. would present considerable space and cost problems. Their discussions with numerous studio engineers have highlighted the mixdown balance situation as top priority for automated control at this time. Naturally, inasmuch as every Neve control console is a one-off custom job for a particular client, they are ready to design a NECAM installation with just as few or as many control functions as requested. ■

Closing date is the fifteenth of the second month preceding the date of issue.
 Send copies to: Classified Ad Dept.
 db THE SOUND ENGINEERING MAGAZINE
 1120 Old Country Road, Plainview, New York 11803

Rates are 50¢ a word for commercial advertisements.
 Employment offered or wanted ads are accepted at 25¢ per word.
 Frequency discounts: 3 times, 10%; 6 times, 20%; 12 times, 33%.

**ONE STOP
 FOR ALL YOUR PROFESSIONAL
 AUDIO REQUIREMENTS
 BOTTOM LINE ORIENTED
 F. T. C. BREWER CO.
 P.O. Box 8057, Pensacola, Fla. 32505**

THE LIBRARY . . . Sound effects recorded in STEREO using Dolby™ throughout. Over 350 effects on ten discs, \$100.00. Write, The Library, P.O. Box 18145, Denver, Colorado 80218.

FOR SALE

CROWN DC-300A's at 20% off. Tascam Model 5's and 80-8's, reduced to sell. Similar saving on Sentry IIIs and IVAs, dbx 216, 187, 177, 152, and other noise reduction units. E-V & Shure mics, AKG BX10s; All NEW-factory guaranteed. Call today, ask for Ben at Rowton Professional Audio, 4815 Clarks River Rd., Rt. 4 Box 5, Paducah, Ky. 42001. (502) 898-6203.

DECOURSEY ACTIVE ELECTRONIC CROSSOVERS. Model 110 dividing network; complete with regulated power supply, for bi-amp, tri-amp, or quad-amp. Custom assembled to meet your specifications. Monaural, stereo, or with derived third channel. Plug-in Butterworth (maximally flat) filters; 6, 12 or 18 dB per octave at any desired frequency. OPTIONS: Summer for single woofer systems, VLF hi-pass filters for elimination of subsonic noise, derived third channel. FOR OEM OR HOME ASSEMBLERS: Model 500 or 600 dual filters. Regulated power supplies. Write for new brochure. DeCoursey Engineering Laboratory, 11828 Jefferson Blvd., Culver City, Ca. 90230. (213) 397-9668.

NEW YORK'S LEADING DEALER specializing in semi-pro and professional recording and p.a. equipment. Teac, Tascam, Sound Workshop, Nakamichi, dbx, MXR, Dynaco, Ads, Frazier, Eventide, Electro-Voice, Shure, Scotch, Maxell, Otari, Ampex, and more. We go both ways: lowest prices in sealed factory cartons, or complete laboratory check-out and installation. All equipment on display. AUDIO BY ZIMET, 1038 Northern Blvd., Roslyn, L.I., New York 11576. (516) 621-0138.

FOR SALE: 16-track erase head. Only used 10 hours. Wired to plug into Ampex MM1000. Will fit any Ampex MM1000, MM1100, or MM1200. Purchased new from Ampex. \$800. Contact: Howard Steele, (213) 466-4306.

PROFESSIONAL MONITOR TUNING. Even the finest control room designs require speaker line tuning for accurate response. Milam Audio uses only the finest Real Time equipment to read and correctly perform monitor tuning. For information, contact: Milam Audio Co., 1504 N. 8th St., Pekin, Ill. 61554. (309) 346-3161.

CUSTOM CROSSOVER NETWORKS to your specifications; a few or production quantities. Power capacities to thousands of watts; inductors and capacitors available separately; specify your needs for rapid quotation. Also, PIEZO ELECTRIC TWEETERS—send for data sheet and price schedules. TSR ENGINEERING, 5146 W. Imperial, Los Angeles, Co. 90045. (213) 776-6057.

MODERN RECORDING TECHNIQUES by Robert E. Runstein. The only book covering all aspects of multi-track pop music recording from microphones through disc cutting. For engineers, producers, and musicians. \$9.95 prepaid. Robert E. Runstein, 44 Dinsmore Ave. Apt. 610, Framingham, Mass. 01701.

AUDIOARTS ENGINEERING Model 5200A professional disco mixer/preamplifier. Audioarts Engineering, 286 Downs Rd., Bethany, Conn. 06525.

AUDIO and VIDEO
On a Professional Level

Lebow Labs specializes in equipment, sales, systems engineering, and installation—full service and demonstration facilities in-house. We represent over 200 manufacturers of professional and semi-professional equipment for recording, broadcast, sound reinforcement, and commercial sound. Call or write for information and pricing (attention Peter Engel).

LEBOW LABS, INC.
 424 Cambridge St.
 Allston (Boston), Mass. 02134
 (617) 782-0600



Order Radford direct from England! Immediate dispatch by air of HD250 stereo amplifier, ZD22 zero distortion preamp, Low Distortion Oscillator ser. 3, Distortion Measuring Set ser. 3, speakers and crossovers. Send for free catalogues, speaker construction plans, etc.

WILMSLOW AUDIO
 Dept. Export DB, Swan Works, Bank Square,
 Wilmslow, Cheshire, England

PRO AUDIO EQUIPMENT & SERVICES

Custom touring sound, 2-, 4-, and 8-track studios, disco systems. Representing Akai, AKG, Allen & Heath, Altec, Beyer, BGW, Cetec, Cerwin-Vega, Community Light & Sound, dbx, Dynaco, Dokorder, Emilar, E-V, Furman, Gauss, Kelsey, Lamb, Langevin, 3M, Martex PM, Maxell, Meteor, Russound, Revox, Sennheiser, Shure, Sony, Soundcraftsman, Sound Workshop, Spectra Sonics, Switchcraft, TDK, TAPCO, TEAC, Technics, Thorens, and more. Offering these professional services: custom cabinet design, room equalization, loudspeaker testing, custom crossover design, electronics modification, and custom road cases. Call or write for quotes, or drop us a line for our latest catalogue. K&L Sound, 75 N. Beacon St., Watertown, Mass. 02172. (617) 787-4073. (Att.: Ken Berger.)

db November 1976 37

(continued)

FOR SALE

PROFESSIONAL SOUND COMPONENTS from Crown, TAPCO, Soundcraft, Bose, Community Light and Sound, dbx, Gauss, Soundcraftsmen, Spider/Peavey, Sound Workshop and many more. Hear it all at **Gary Gand Music, 172 Skokie Valley Road, Highland Park, Illinois 60035, (312) 831-3080.**

TEST RECORD for equalizing stereo systems. Helps you sell equalizers and installation services. Pink noise in 1/3 octave bands, type QR-2011-1 @ \$20. Used with precision sound level meter or B & K 2219S. **B&K Instruments, Inc., 5111 W. 164th St., Cleveland, Ohio 44142.**

DUPLICATORS, blank cassettes, recorders, boxes, labels, cassette albums and supplies; lowest prices, top quality. Write for free brochure, "50 Tips for Better Duplication." **Stanford International, Box 546, San Carlos, Ca. 94070.**

COMMUNITY LIGHT & SOUND professional sound products. **Brandy Brook Audio, P.O. Box 165, Seymour, Connecticut 06483. (203) 888-7702.**

AUDIOARTS ENGINEERING Model 3100A parametric equalizer/preamplifier. **Audioarts Engineering, 286 Downs Rd., Bethany, Conn. 06525.**

AST: THE PROFESSIONAL SOUND STORE. Full line of ALTEC and CROWN professional audio, commercial, and musical sound equipment; GAUSS and CERWIN-VEGA speakers; factory authorized service on most speakers. Large stock of ALTEC replacement diaphragms available. **AST, 281 Church St., New York, N.Y. 10013. (212) 226-7781.**

FOR SALE: AMPEX 351-2, good shape, \$1,500; Ampex 351 stereo PB deck, \$750. Call **(415) 383-0479.**

BODE FREQUENCY SHIFTERS SINCE 1963

Professional quality frequency shifters for electronic music studios (Models 735 & 750). Anti-feedback model 741 for p.a. systems. Also featuring polyfusion synthesizer modules and systems. For details contact:

**Harald Bode
BODE SOUND COMPANY
1344 Abington Pl.,
N. Tonawanda, N.Y. 14120
(716) 692-1670**

NAGY SHEAR-TYPE TAPE SPLICERS



FOR CASSETTE 1/4 & 1/2 IN. TAPES
• HAND-CRAFTED
• FIELD PROVEN
• FAST, ACCURATE
• SELF-SHARPENING

NRPD Box 289 McLean, Va. 22101

VARI-SPEED for Ampex MM-1100, AG 440-C; d.c. servo motors only. \$229 each. Manufacturer, **MCH Electronics, 6801 Jericho Tpke., Syosset, N.Y. 11791. (516) 364-8666.**

NAB ALUMINUM FLANGES. We manufacture 8", 10 1/2", & 14". For pricing, write or call **Records Reserve Corp., 56 Harvester Ave., Batavia, N.Y. 14020. (716) 343-2600.**

DUPLICATOR REPAIR CENTER for all brands of in-cassette duplicators. Factory-trained technicians. Work warranted. Also big selection of new and used duplicators. **Tape and Production Equipment Company, 2065 Peachtree Industrial Court, Atlanta, Ga. 30341.**

AMPEX SCULLY TASCAM, all major professional audio lines. Top dollar trade-ins. 15 minutes George Washington Bridge. **Professional Audio Video Corporation, 342 Main St., Paterson, N.J. 07505. (201) 523-3333.**

AMPEX TAPE. Ampex Audio studio mastering tapes; 631-641, 406-407, and "Grand Master" in stock for immediate shipment; 1/4", 1" and 2"; factory fresh. Best prices. **Techniarts, 8555 Fenton St., Silver Spring, Md. 20910. (301) 585-1118.**

STUDIO SOUND—Europe's leading professional magazine. Back issues available from June '73 through June '75. \$1 each, postpaid. **3P Recording, P.O. Box 99569, San Francisco, Ca. 94109.**

CLASSES IN 16/24 track music recording techniques, disc mastering, record production. Taught by famous engineers and producers at modern recording studios. **Saga of Sound, 9200 Sunset #808, Hollywood, CA 90069, (213) 550-0570.**

FREE CATALOG & AUDIO APPLICATIONS



CONSOLES
KITS & WIRED
AMPLIFIERS
MIC, EQ, ACN,
LINE, TAPE, DISC,
POWER
OSCILLATORS
AUDIO
TAPE BIAS
POWER SUPPLIES

OPAMP LABS, INC.
1023 N. SYCAMORE AVE.
LOS ANGELES, CALIF 90038
(213) 914-2966

INFONICS DUPLICATORS! For a bunch of reasons, you can't afford not to consider Infonics Duplicators — especially since factory installation and training are included in the list price. **INFONICS DUPLICATORS, (219) 879-3381.**

\$2 MILLION USED RECORDING EQUIPMENT. Send \$1.00 for list, refundable, to **The Equipment Locator, P.O. Box 99569, San Francisco, Ca. 94109. 94109.**

ARP SYNTHESIZERS: Strings, \$1,385; 2600, \$2,190; Axxe, \$700; Prosololst, \$875, Odyssey, \$1,165. **Dickstein Distributing, 1120 Quincy, Scranton, Pa. 18510.**

MCI . . . the finest name in Audio Recorders and Consoles, now offers one-to 24-track master recorders and up to 40-in/40-out automated consoles. For midwest factory representation, contact: **Milam Audio Co., 1504 N. 8th St., Pekin, Ill. 61554. (309) 346-3161.**

DYNACO RACK MOUNTS for all Dynaco preamps, tuners, integrated amps. \$24.95 postpaid in U.S., \$22.50 in lots of three. **Audio by Zimet, 1038 Northern Blvd., Roslyn, N.Y. 11576. (516) 621-0138.**

FREE CATALOG of studio kits, consoles, p.a., discrete opamps. **QCA, Box 1127, Burbank, Ca. 91507.**

AMPEX 300, 352, 400, 450 USERS—for greater S/N ratio, replace first playback stage 12SJ7 with our plug-in transistor preamp. For specifications, write **VIF International, Box 1555, Mountain View, Ca. 94042. (408) 739-9740.**

FOR SALE: MCI JH-114 16-track with autolocator, \$15,750; ITI Parametric equalizers, MEP-230, \$925—MEP-130, \$425; Audio Techniques Mastering Labs Monitors—Big Reds, \$475—Super Reds, \$675; Pandora Time Line, \$2,500; used tape with reel and box—1/2", \$5.00; 1", \$10.00; 2", \$20.00. **Sound 80, Inc., 2709 E. 25th St., Minneapolis, Minn. 55406. (612) 721-6341.**

AUDIOARTS ENGINEERING, 286 Downs Rd., Bethany, Conn. 06525. Tolex-covered portable 19 in. rack equipment cases.

SMC DP-1 automation system; 7 carousels; time announce; 3 reels; 5 decks; all accessories. 5 years old. Call or write: **WHIT Radio, P.O. Box 1049, New Bern, N.C. 28560. (919) 637-4450.**

FOR SALE: Two Ampex MM1000 16-track recorders; wired for 24 and spares. **Record Plant Studios. (212) 581-6505.**

REELS AND BOXES 5" and 7" large and small hubs; heavy duty white boxes. **W-M Sales, 1118 Dula Circle, Duncanville, Texas 75116. (214) 296-2773.**

FOR SALE: ELECTRODYNE custom ACC 2416 control console w/producer's desk, 24-in/16-out quad, 2-track, plus mono mixdown capabilities; 4 echo sends and returns, plus many other features. Cost \$52,293, asking \$18,000. Call **Mother Music Sound Recorders, 415 N. Tustin Ave., Orange, Ca. 92667, (714) 639-6420.**

THE RESONATOR is more than a reverb. Designed for use with any console, including Tascam. \$359.00. **Dyma, Box 1697, Taos, N.M. 87571.**

FOR SALE OR LEASE. Scully stereo cutting lathes; nearly new; full automation; in mint condition. Second lathe VP only. Will consider trade-in equipment for partial payment. **Universal Audio Sales, 40 E. Thomas, Phoenix, Az. 85012. (602) 263-9072.**

SONY TC 854-4S 4-track deck w/sync, about 12 hrs. total use, 8-in/4-out miner, no eq., \$2,500 CDN. **Chris Doole, #1206-240 Stradbrook, Winnipeg, Manitoba, Canada.**

FOR SALE: LIKE NEW AND USED EQUIPMENT. Recorders (unmounted): Ampex AG 440-B8 deck, excellent condition, heads and electronics good, \$5,500.00; Ampex 354 stereo, good condition, \$1,000.00. Mixers: Interface series 300, 20 in/8 out, expandable to 24, excellent condition, \$6,500.00. Interface series 100, Stevenson 8 x 4 main frame without modules, like new condition, \$350.00. Miscellaneous: AR LST speakers (2), excellent condition, \$450.00 each. Patch bays (2), 48 position, tiny telephone, pre-wired with terminal blocks, \$200.00 each. **Bill Castner, 2419 Illinois, Flint, Michigan. (313) 767-5095.**

12-TRACK SCULLY—284-12; new heads, in console. \$7,500. **(212) 838-3212.**

YELLOW PAGES OF AUDIO—\$3.95. Information upon request. **Box 94-D, Colmar, Pa. 18915.**

ELECTRO-VOICE SENTRY PRODUCTS. In stock: Sentry IV-B, Sentry III, and Sentry V monitor loudspeaker systems for professional monitoring and sound reinforcement. Immediate air freight shipment to any N. American destination. Florida dealer inquiries invited. **National Sound Co., Ft. Lauderdale, Florida. (305) 462-6862.**

A.P.I. CONSOLE relay problems? New sealed assemblies now available. **Channel Islands Audio, Box 6686, Oxnard, Ca. 93030. (805) 483-7351.**

3M 4-TRACK/IN CONSOLE, 15-30 i.p.s., excellent, \$3,900; Sony C-57 condenser microphone, \$125; Countryman 967 phase shifter, \$190; V.S.O. McIntosh 200 watt, \$400; 4 Studer A-80 Mark I electronics (100 hrs. use), \$800 each; AKG-BX 20E reverb w/remote, \$2,500 or best offer; J.B.L. 4350 speakers, \$1,050 each, still in warranty. **(213) 461-3717, ask for Brian.**

SCULLY MS-282-4, portable cases, motion sense, remote, mint condition. **(313) 779-1685 Sunday after 6:00 P.M.**

AMPEX SERVICE COMPANY: Complete factory service for Ampex equipment; professional audio; one-inch helical scan video; video closed circuit cameras; video systems; instrumentation and consumer audio. Service available at **2201 Lunt Avenue, Elk Grove Village, IL 60007; 500 Rodier Drive, Glendale, CA 91201; 75 Commerce Way, Hackensack, NJ 07601.**

CROWN INTERNATIONAL. Complete repair, overhaul, and rebuilding service for current and early model Crown tape recorders and amplifiers. New and used machines bought and sold. **TECHNIARTS, 8555 Fenton St., Silver Spring, Md. 20910. (301) 585-1118.**

WHATEVER YOUR EQUIPMENT NEEDS—new or used—check us first. We specialize in broadcast equipment. Send \$1.00 for our complete listings. **Broadcast Equipment & Supply Co., Box 3141, Bristol, Tenn. 37620.**

A FEW competitively priced used Revox A77 and A700 decks available. Completely reconditioned by Revox, virtually indistinguishable from new and have the standard Revox 90-day warranty for rebuilt machines. Satisfaction guaranteed. Write requirements to **ESS1, Box 854, Hicksville, N.Y. 11802. (516) 921-2620.**

EMPLOYMENT

AUDIO/ELECTRONIC ENGINEER needed for custom design, construction, repair and maintenance of professional audio equipment. Four studios include 16-track, location and film. Permanent position. **RECORDIST/MIXER** needed for music recording. Experience in commercial jingle work preferable. Permanent position. **Dept. 101, 1120 Old Country Road, Plainview, NY 11803.**

AUDIO TALENT WANTED, NYC. Engineers, Jr. engineers, wiremen experienced in working on large scale audio systems such as theaters, ballrooms, stadiums, hotels, schools, etc. Our personnel know of this advertisement. Write, giving experience and qualifications and salary requirements to **Dept. 114, db Magazine, 1120 Old Country Rd., Plainview, N.Y. 11803.**

I DESIRE EMPLOYMENT at Dictaphone or Ampex, starting as Test Technician Trainee or Assembler. My applications are on file. Strong desire to learn. Look toward future as Multitrack Technician. **Mike Erickson, 96 S. 17th St., San Jose, Ca. 95112. (408) 298-2862.**

SALES ENGINEER. Manufacturer of audio/acoustic components requires self-motivated individual, able to work independently, to establish and cover nationally, OEM accounts in the electronic industry. Background must include BSEE degree as well as selling experience. Please submit resume, including salary requirements, to **Dept. 111, db Magazine, 1120 Old Country Rd., Plainview, N.Y. 11803.**

24-TRACK STUDIO in San Juan, Puerto Rico seeks experienced recording-mixing engineer. Excellent opportunities. Send resume or call **Ochoa Recording Studios, Inc., GPO Box 3002, San Juan, Puerto Rico 00936. (809) 764-4440.**

EXPERIENCED MUSIC MIXER
For major N.Y.C. studio, expanding staff. Send resume to **Dept. 72, db Magazine, 1120 Old Country Rd., Plainview, NY 11803.**

BUSINESS OPPORTUNITIES

WANTED: Investment capital or recording equipment for new studio with excellent potential. Owner experienced professional engineer and studio manager. Principals only. **Dept. 113, db Magazine, 1120 Old Country Rd., Plainview, N.Y. 11803.**

PRODUCERS-ENGINEERS—8-track studio time available, mid-Manhattan. Fully equipped. **(212) 852-3295.**

RECORDING STUDIO. Investors needed for major new studio planned for major city in western Pennsylvania. Fantastic opportunity and potential. Investments partially secured by equipment and real estate. For prospectus write to **Studio Consultants, 24324 Gilmore St., Canoga Park, Ca. 91307.**

● **Switchcraft, Inc.** of Chicago has purchased the thumbwheel and rotary switch lines of **Chicago Dynamic Industries, Inc.** The new line has been incorporated into Switchcraft's production at their Chicago facility.

● Management and marketing structures for the **Cetec Broadcast Group** formed of five divisions of the **Cetec Corporation** have been finalized. **Robert M. Ward** will be responsible for group sales and marketing with headquarters in Santa Barbara, Ca. **Jay Cook** has been named advertising manager. The five divisions are Schaffer, which produces automated radio systems; Jampro Antenna, f.m. and t.v. transmitting antennas; Sparta, transmitters and radio studio broadcast systems; Vega, wireless microphones, and Cetec Audio, studio consoles, professional tape reproducers, and loudspeakers.

● **Allen and Heath, Ltd.**, manufacturers of mixing equipment, and tape deck manufacturer **Brenell, Ltd.** have joined forces. Their combined facility is located at Pembroke House, Campsbourne Rd., Hornsey, London, N8 England.

● **Joachim P. Diermann** has been appointed chief engineer of the audio-video systems division of the **Ampex Corporation**, Redwood City, Ca. Mr. Diermann has conducted development work at Ampex, with whom he has been associated since 1966. Among his projects were electron beam recording, computer and data technology and the Electronic Still Storage system.

● **Sigma Instruments, Inc.** of Braintree, Mass, has appointed **Jerome J. Tuite** as regional sales manager for switching products. Mr. Tuite will be responsible for sales and marketing in the eastern region. Before coming to Sigma, Mr. Tuite was with the **Siemens Corporation**.

GEORG NEUMANN



Georg Neumann, a pioneer in the field of audio recording and the inventor of the gas-tight nickel cadmium battery, died at his home in West Berlin on August 30, 1976 at the age of 77.

Georg Neumann was born on October 13, 1898 and has been closely associated with the development of sound recording and reproduction techniques since the middle twenties. As a young engineer, he developed a carbon microphone, known as the Reisz microphone, displaying remarkable improvement over carbon granule types then in common use. In 1928, Georg Neumann produced the first commercial condenser microphones and since then these have been preeminent in their field. The high fidelity recording was born with the advent in 1948 of the long playing record recorded with the now-classic Neumann U47 condenser microphone, and Hi-Fi became a household word as a result.

In 1930 Georg Neumann developed the first of a long line of

disc mastering lathes, as well as one of the first electro-mechanical disc cutting heads and in 1957 his company introduced the world's first stereophonic disc recording system.

Some of his other inventions covered the first linear motion pen level recorder, a device used by all manufacturers of such recorders today. During World War II, Mr. Neumann developed, and soon after the war, patented, the world's first gas-tight rechargeable nickel cadmium battery, without which space exploration would not be possible.

Georg Neumann was awarded Honorary Membership in the Audio Engineering Society in 1973. In March, 1976 he was awarded the Society's highest honor, its Gold Medal, which he accepted in person at the Society's European Convention held in Switzerland.

He is survived by his wife Elly, and two children, Dr. Ralf Neumann and Mrs. Ingrid Canetti, both living in Paris.

once is enough!

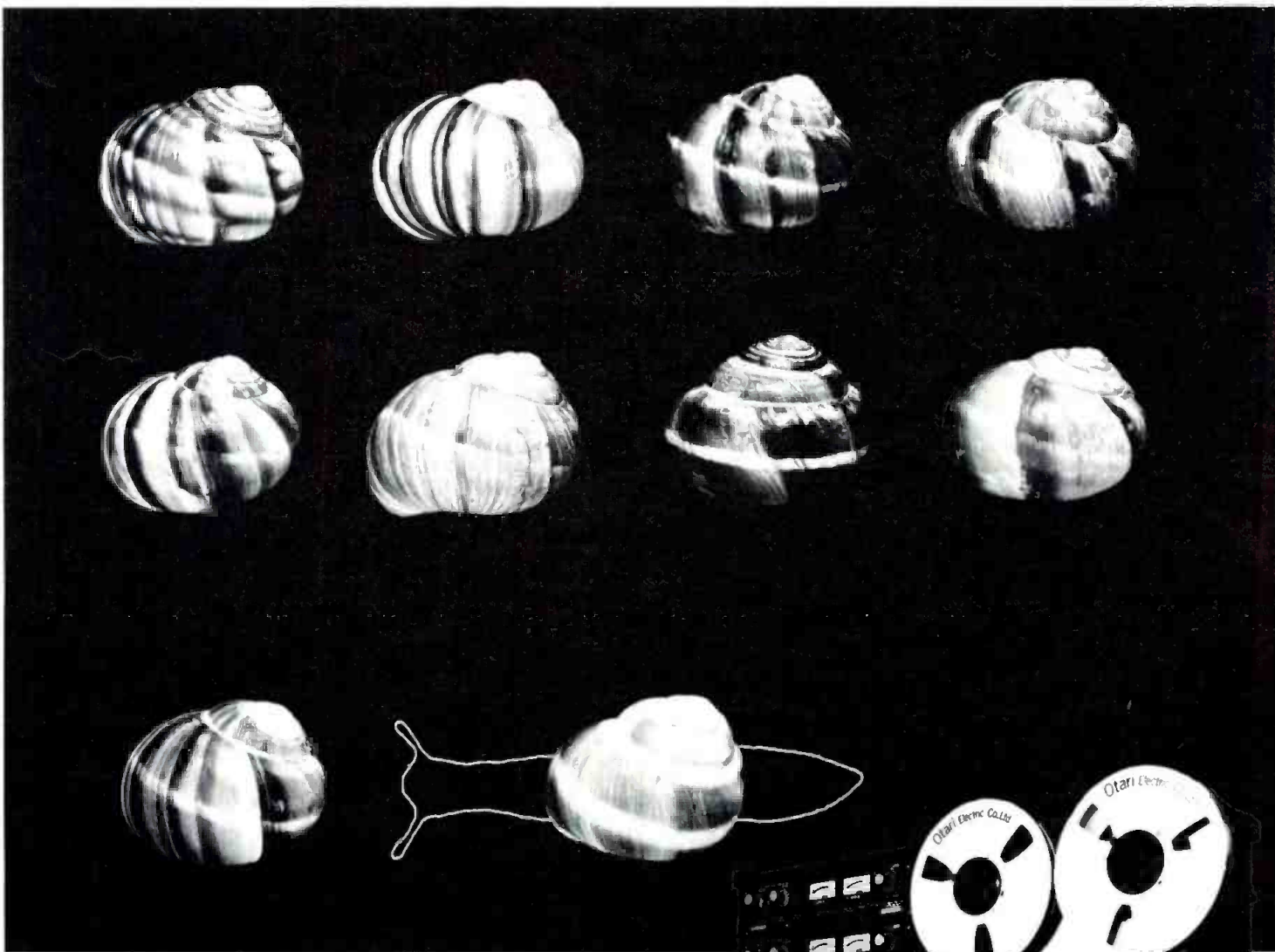

The snail moves slowly and steadily. But think! The weight of the shell that the snail carries is two to three times the weight of its own body; this is equivalent to a 175 pound man walking steadily forward with a 400 pound weight on his shoulders.

Such steady performance under hard use conditions is also characteristic of Otari products. Years of continuous service is common, and the response of professional users shows how much they value this steady, precise performance under hard use.

We don't have to claim our machines are sturdy—the machines, and their satisfied users, speak for themselves.

Trust through experience — one encounter with OTARI equipment and from then on, You will trust the OTARI name.

MX-5050-8SD

OTARI

OTARI CORPORATION: 981 Industrial Road, San Carlos, California 94070. U.S.A. Phone: California 415-593-1648 Telex No. 259103764890 OTARICORP SCLS
OTARI ELECTRIC CO., LTD. 4-29-18. Minami Ogikubo, Suginami-ku, Tokyo, 167 Japan Phone: (03) 333-9631 Cable: OTARIDENKI TOKYO Telex: J26604 OTRDENKI

Circle 11 on Reader Service Card

www.americanradiohistory.com

Think of them as your musical instruments.



The audience can't see you. But they can sure hear you.

They don't know it, but they're depending on just one person to get the music to them. And that guy is you.

It's not something an amateur can do. It's an art. And that's why Yamaha has designed 3 superb mixing consoles with the qualities and range of controls that the professional sound reinforcement artist needs.

For instance, our exclusive 4x4 matrix with level controls gives you more exacting mastery over your sound than the conventional method of driving speaker amps directly from the bus outputs.

Features like that are years away except on the most expensive mixers. On the Yamahas, it's standard equipment. And so are transformer

isolated inputs and outputs, dual echo send busses, an input level attenuator that takes -4 dB line level to -60 dB mike level in 11 steps, and 5-frequency equalization.

Whether you choose the PM-1000-16, the PM-1000-24 or the PM-1000-32, Yamaha gives you the flexibility you need to turn your job into an art. And because they're designed from the ground up to perform on the road, more and more professional sound men around the United States and the world are depending on Yamaha, night after night, gig after gig.

If you've never thought of your mixing console as a musical instrument, we'd like to invite you to stop by your Yamaha dealer. Once you've checked out the operation manual and tested for yourself what the PM Series can do, we think you'll come away a believer.



Box 6600, Buena Park, CA 90620

Circle 12 on Reader Service Card

www.americanradiohistory.com